

09

BATTERY CONNECTORS & CABLE

CONNECTEURS ET
CÂBLES DE BATTERIE

TERMINALES Y CABLES
PARA BATERIA

- 130 Battery Connectors
- 138 Conversion Connectors and Adapters
- 140 Booster Clamps and Cables
- 141 Charging Clips
- 142 Booster Cable – Twin Conductor
- 144 Battery Cables
- 148 Battery Disconnect Switches
- 149 Battery Protective Products
- 150 Crimpers and Cutters
- 152 Battery Boxes
- 155 Hold-downs and Trays
- 156 Portable Power Packs & Chargers
- 158 Battery Cable
- 159 Welding Cable



GROTE'S HAS A COMPLETE LINE OF BATTERY CONNECTORS, CABLE, REPLACEMENT AND SERVICE PARTS, TEST CLIPS AND TERMINAL PROTECTIVE PRODUCTS AND OF COURSE CHARGING OPTIONS FOR ALL OF YOUR EQUIPMENT'S POWER DELIVERY NEEDS.

LIGHT DUTY, HOME AND GARDEN EQUIPMENT, HEAVY VEHICLE OR INDUSTRIAL APPLICATIONS – GROTE HAS THE BATTERY CONNECTION PRODUCT YOU NEED!



Proper connections to a vehicles power supply are vital to performance. Make the right choice – go with Grote Battery Connectors and Cables.

DIE-CAST BATTERY CONNECTORS



- Copper die-cast and bright tin plating exceeds SAE J163 & J1811 conductivity standards by 25 times
- Ultra-smooth, pit-free cast surface resists against harmful materials and corrosion
- Can be crimped or soldered; can be installed with most major crimping tools
- Provides full height post connection
- Includes 5/16" battery bolts and shoulder nuts; fasteners included
- Clamps are marked for easy identification
- Listed by UL STD. 486A & cUL® US when applied with Hex Crimp 84-9082
- Made in North America; Available in Retail and Bulk sizes
- Rated to 600V; lead-free

STRAIGHT BARREL CLAMP



CABLE GAUGE	COLOR CODE	RETAIL PACK SIZE	NEGATIVE	POSITIVE	BULK PACK SIZE	NEGATIVE	POSITIVE
4	Grey	1	82-9053	82-9054	5	84-9053	84-9054
2	Green	1	82-9050	82-9051	5	84-9050	84-9051
1	Pink	1	82-9047	82-9048	5	84-9047	84-9048
1/0	Black	1	82-9056	82-9057	5	84-9056	84-9057
2/0	Orange	1	82-9058	82-9059	5	84-9058	84-9059
3/0	Purple	1	82-9060	82-9061	5	84-9060	84-9061
4/0	Yellow	1	82-9062	82-9063	5	84-9062	84-9063

FLAG CONNECTOR



CABLE GAUGE	COLOR CODE	RETAIL PACK SIZE	NEGATIVE	POSITIVE	BULK PACK SIZE	NEGATIVE	POSITIVE
1/0	Black	1	82-9095	82-9096	5	84-9095	84-9096
2/0	Orange	1	82-9097	82-9098	5	84-9097	84-9098
3/0	Purple	1	82-9099	82-9100	5	84-9099	84-9100
4/0	Yellow	1	82-6010	82-6011	5	84-6010	84-6011

RIGHT AND LEFT ELBOW



CABLE GAUGE	COLOR CODE	ANGLE	RETAIL PACK SIZE	NEGATIVE	POSITIVE	BULK PACK SIZE	NEGATIVE	POSITIVE
1/0	Black	Right	1	82-9640	82-9641	5	84-9640	84-9641
1/0	Black	Left	1	82-9642	82-9647	5	84-9642	84-9647
2/0	Orange	Right	1	82-9648	82-9649	5	84-9648	84-9649
2/0	Orange	Left	1	82-9650	82-9651	5	84-9650	84-9651
3/0	Purple	Right	1	82-9652	82-9653	5	84-9652	84-9653
3/0	Purple	Left	1	82-9654	82-9655	5	84-9654	84-9655

• Use on stud style batteries

CABLE GAUGE	COLOR CODE	5/16" (8 MM)	3/8" (10 MM)	1/2" (12 MM)	PACK SIZE
4	Grey	84-9105	84-9106	–	5
2	Green	–	84-9103	–	5
1	Pink	–	84-9101	–	5
1/0	Black	–	84-9108	84-9109	5
2/0	Orange	–	84-9110	84-9111	5
3/0	Purple	–	84-9112	84-9113	5
4/0	Yellow	–	84-9114	84-9115	5

HEAVY WALL COPPER LUGS



84-9110

STUD/SIDE LOCKING LUG



84-9309

SPLICES – TIN PLATED

- Seamless 100% copper tube construction
- Heavy tin-plated for superior conductivity and resistance to corrosion
- Can be crimped or soldered – ideal for most applications

CABLE GAUGE	RETAIL PACK	PACK SIZE	BULK PACK	PACK SIZE
8	82-9552	2	84-9552	10
6	82-9463	2	84-9463	10
4	82-9448	2	84-9448	10
2	82-9553	2	84-9553	10
1	82-9554	2	84-9554	10
1/0	82-9555	2	84-9555	10
2/0	82-9556	2	84-9556	10
3/0	82-9557	2	84-9557	10
4/0	82-9558	2	84-9558	10



84-9448



82-9556

UNINSULATED BRAZED SEAM LUGS

- 100% copper tin-plated
- Serrated barrel increases pull-out strength of hard-to-crimp wire
- Can be crimped or soldered
- Ideal for solder dipping applications
- Lead-free

CABLE GAUGE	STUD SIZE	BULK PACK	PACK SIZE
8	#10	84-9548	10
6	1/2"	84-9442	10
4	1/2"	84-9443	10



84-9443

MAGNALUG® CONNECTORS

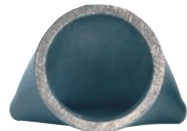

STANDARD LUG

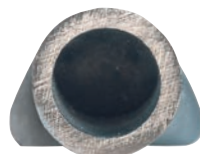

MAGNALUG®

- MagnaLugs® are superior to standard tube lugs
- Wider pad for better electrical contact; thicker pad for greater strength & conductivity
- Exceeds SAE conductivity standards J163 and J1811
- MagnaLugs® listed by UL STD. 486A & cUL® US when applied with Hex Crimp 84-9082
- Up to 80% heavier wall than standard lugs
- Made of 100% copper, tin-plated twice as thick as industry standards
- For truck, bus, farm or construction equipment
- Excellent for commercial or industrial applications
- Flameless installation, safe for repair shop or field repair
- Lead-free

STARTER/GROUND COPPER LUGS



84-9208

CABLE GAUGE	COLOR CODE	1/4" (6 MM)	5/16" (8 MM)	3/8" (10 MM)	1/2" (12 MM)	PACK SIZE
8	Grey	84-9461	84-9635	—	—	5
6	Grey	—	—	84-9636	—	5
4	Grey	84-9199	—	84-9200	84-9201	5
1 & 2	Pink	84-9196	—	84-9197	84-9198	5
1/0	Black	84-9202	—	84-9203	84-9204	5
2/0	Orange	84-9205	84-9637	84-9206	84-9207	5
3/0	Purple	—	—	84-9208	84-9209	5
4/0	Yellow	—	—	84-9210	84-9211	5

LOCKING ANTI ROTATIONAL STACKABLE LUG



84-9192

CABLE GAUGE	COLOR CODE	3/8" (10 MM)	PACK SIZE
1/0	Black	84-9192	5
2/0	Orange	84-9193	5

SPLICES



84-9220

CABLE GAUGE	COLOR CODE	RETAIL PACK	PACK SIZE	BULK PACK	PACK SIZE
4	Grey	82-9219	2	84-9219	10
1 & 2	Pink	82-9218	2	84-9218	10
1/0	Black	82-9220	2	84-9220	10
2/0	Orange	82-9221	2	84-9221	10
3/0	Purple	—	2	84-9222	10
4/0	Yellow	—	2	84-9223	10



DEAL WITH REAL

In a world of automated phone systems and outsourced customer service it's rare to contact **REAL PEOPLE** with **REAL EXPERIENCE** providing **REAL SOLUTIONS**. That is exactly what you get from Grote's team of expert Sales and Customer Solutions personnel.

FLEET SUPPORT

As a fleet manager, you don't have time to waste worrying about inventory and products. That's why we offer a full service partnership. You won't have to worry about inventories or suppliers. Grote can provide comprehensive training to your maintenance partners, to ensure you get the most benefit from your Grote Electrical Connections and Accessory products.

Limit unplanned maintenance downtime, increase the profitability of your fleet and improve your fleet's safety through proven electrical connection and accessory products that withstand everything your vehicles face in day-to-day work. Find out more about how these products affect your fleet's profitability, and how Grote can maximize your return with our innovative, industry-leading Electrical Connection and Accessory solutions.

CONTACT US AT 1-800-268-5612 TO FIND OUT HOW WE CAN HELP YOUR BUSINESS



©2018 Grote Industries Canada. Grote® and G24/7™ are trademarks of Grote Industries Inc. All rights reserved.

TIN PLATED COPPER TUBE LUGS

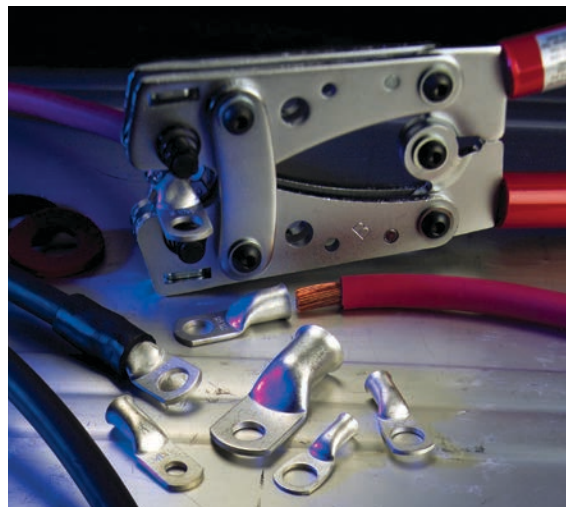

- Seamless 100% copper tube construction
- Can be crimped/soldered; ideal for general wiring, starter, ground applications
- Heavy tin-plated for superior conductivity and resistance to corrosion
- Flared barrel for easy installation of cables
- Available in clam shell packaging or bulk bag
- Lead-free



CABLE GAUGE	STUD SIZE	RETAIL PACK	PACK SIZE	BULK PACK	PACK SIZE
8	#10	82-9164	2	84-9164	25
8	1/4"	82-9165	2	84-9165	25
8	5/16"	82-9537	2	84-9537	25
8	3/8"	82-9523	2	84-9523	25
8	1/2"	82-9547	2	84-9547	25
6	#10	82-9524	2	84-9524	25
6	1/4"	82-9166	2	84-9166	25
6	5/16"	82-9167	2	84-9167	25
6	3/8"	82-9168	2	84-9168	25
6	1/2"	82-9525	2	84-9525	25
4	1/4"	82-9317	2	84-9317	25
4	5/16"	82-9169	2	84-9169	25
4	3/8"	82-9170	2	84-9170	25
4	1/2"	82-9527	2	84-9527	25
2	1/4"	82-9318	2	84-9318	25
2	5/16"	82-9319	2	84-9319	25
2	3/8"	82-9171	2	84-9171	25
2	1/2"	82-9172	2	84-9172	25
1	1/4"	82-9528	2	84-9528	25
1	5/16"	82-9533	2	84-9533	25
1	3/8"	82-9173	2	84-9173	25
1	1/2"	82-9174	2	84-9174	25
1/0	1/4"	82-9535	2	84-9535	25
1/0	5/16"	82-9534	2	84-9534	25
1/0	3/8"	82-9175	2	84-9175	25
1/0	1/2"	82-9176	2	84-9176	25
2/0	5/16"	82-9536	2	84-9536	25
2/0	3/8"	82-9177	2	84-9177	25
2/0	1/2"	82-9178	2	84-9178	25
3/0	3/8"	82-9179	2	84-9179	25
3/0	1/2"	82-9180	2	84-9180	25
4/0	3/8"	82-9181	2	84-9181	25
4/0	1/2"	82-9182	2	84-9182	25



84-9175



83-6544

TIN PLATED COPPER TUBE LUG ASSORTMENT KIT

- Includes 76 of the most popular automotive & heavy duty copper tube lugs
- Heavy tin plated for superior conductivity and resistance to corrosion
- Can be crimped or soldered
- 12 compartment re-closable box with re-order chart on inside cover

83-6544 8 – 3/0 GA Copper Tube Lugs

STANDARD COPPER TUBE LUGS

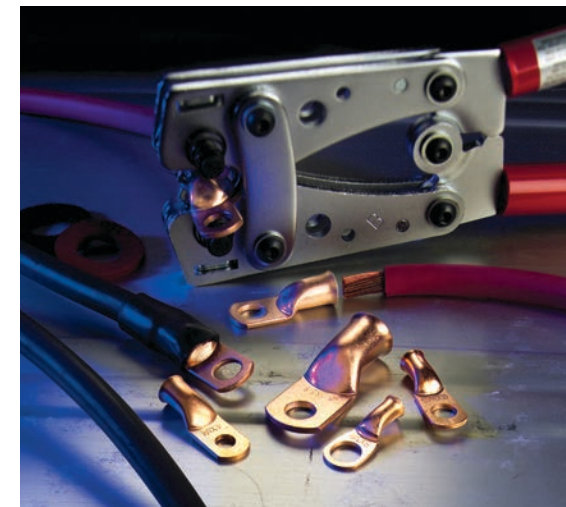

- Seamless 100% copper tube construction
- Can be crimped or soldered – ideal for most general purpose applications
- Flared barrel for easy installation of cables
- Available in clam shell packaging or bulk bag
- Lead-free



CABLE GAUGE	STUD SIZE	RETAIL PACK	PACK SIZE	BULK PACK	PACK SIZE
8	#10	82-9521	2	84-9521	25
8	5/16"	82-9538	2	84-9538	25
8	3/8"	82-9428	2	84-9428	25
8	1/2"	82-9539	2	84-9539	25
6	#10	82-9514	2	84-9514	25
6	1/4"	82-9522	2	84-9522	25
6	5/16"	82-9512	2	84-9512	25
6	3/8"	82-9429	2	84-9429	25
6	1/2"	82-9513	2	84-9513	25
4	1/4"	82-9515	2	84-9515	25
4	5/16"	82-9516	2	84-9516	25
4	3/8"	82-9430	2	84-9430	25
4	1/2"	82-9529	2	84-9529	25
2	1/4"	82-9517	2	84-9517	25
2	5/16"	82-9518	2	84-9518	25
2	3/8"	82-9431	2	84-9431	25
2	1/2"	82-9530	2	84-9530	25
1	1/4"	82-9519	2	84-9519	25
1	5/16"	82-9531	2	84-9531	25
1	3/8"	82-9432	2	84-9432	25
1	1/2"	82-9520	2	84-9520	25
1/0	1/4"	82-9545	2	84-9545	25
1/0	5/16"	82-9532	2	84-9532	25
1/0	3/8"	82-9433	2	84-9433	25
1/0	1/2"	82-9434	2	84-9434	25
2/0	5/16"	82-9546	2	84-9546	25
2/0	3/8"	82-9435	2	84-9435	25
2/0	1/2"	82-9436	2	84-9436	25
3/0	3/8"	82-9437	2	84-9437	25
3/0	1/2"	82-9438	2	84-9438	25
4/0	3/8"	82-9439	2	84-9439	25
4/0	1/2"	82-9440	2	84-9440	25



84-9436



83-6543

COPPER TUBE LUG ASSORTMENT KIT

- Includes 76 of the most popular automotive & heavy duty copper tube lugs
- Provides superior conductivity
- Can be crimped or soldered
- 12 compartment re-closable box
- Re-order chart on inside cover

83-6543 8 – 3/0 GA Copper Tube Lugs



BATTERY CONNECTORS – HEAVY DUTY



84-9133

- Clamps designed for truck, bus, construction, agricultural, industrial applications
- Polarity-specific brass or universal polarity lead construction; hardware included
- Accept 1 through 4/0 gauge cable

DESCRIPTION	MATERIAL	RETAIL PACK	PACK SIZE	BULK PACK	PACK SIZE
Universal Clamp 1-4/0 Gauge	Lead; zinc-plated, steel fasteners	82-9133	2	84-9133	25

BATTERY CONNECTORS – AUTOMOTIVE



82-9613

84-9134

84-9126

- Automotive and light truck applications
- Universal clamp and side terminal styles; constructed of lead or brass
- Accept 6 through 2/0 gauge cable sizes
- Zinc-plated steel hardware included

DESCRIPTION	MATERIAL	RETAIL PACK	PACK SIZE	BULK PACK	PACK SIZE
Universal Clamp	Lead; zinc-plated, steel fasteners	82-9135	2	84-9135	25
Universal Clamp	Brass; zinc-plated, steel fasteners	82-9126	1	84-9126	25
Universal Clamp	Lead; epoxy coated 1 red, 1 black	82-9613	2		
Universal Side Terminal	Lead; zinc-plated, steel fasteners	82-9134	2	84-9134	25

AUTOMOTIVE TERMINAL CLAMPS



84-9671

TOP POST & SIDE MOUNT, CARDS OF 10

- Both products offered in convenient cards of 10 pieces per card
- Both accept 6 through 2/0 gauge cable

PART #	DESCRIPTION
84-9671	Automotive Top Post Terminal Clamps
84-9672	Automotive Side Mount Terminal Clamps

LEAD FREE CONNECTORS



84-9618

82-9597

- Accept 8 through 4 gauge cable sizes
- Tin plated alloy resists corrosion
- For recreational and light duty applications

DESCRIPTION	BULK PACK	PACK SIZE
Top Post, 8-6-4 GA	84-9618	5 Pair (Pos/Neg)
Top Post, 8-6-4 GA, with auxiliary take off	82-9597	1 Pair (Pos/Neg)

- Converts battery post to stud connector
- Permits quick disconnection from battery; eliminates current drain during storage
- Polarity-specific; meets U.S. Coast Guard regulations
- Brass or lead construction; hardware included



DESCRIPTION	SIZE	MATERIAL	RETAIL PACK	PACK SIZE	BULK PACK	PACK SIZE
Top Post; Positive	5/16"	Brass; zinc-plated steel fasteners	82-9124	1	84-9124	25
Top Post; Positive	3/8"	Lead; zinc-plated steel fasteners	82-9541	1	84-9541	25
Top Post; Negative	5/16"	Brass; zinc-plated steel fasteners	82-9125	1	84-9125	25
Top Post; Negative	5/16"	Lead; zinc-plated steel fasteners	82-9542	1	84-9542	25

BATTERY CONNECTORS – MARINE



84-9124

84-9542

BATTERY CONNECTORS – MILITARY



84-9580

- Exceeds military specifications # A52425-1 & A52425-2
- Low profile design, only 3/4" high
- Long bolt permits additional power connections

DESCRIPTION	MATERIAL	BULK PACK	PACK SIZE
Top Post; Positive	Lead; zinc plated steel fasteners	84-9581	5
Top Post; Negative	Lead; zinc plated steel fasteners	84-9580	5

- Accept 2 through 1/0 gauge cable sizes
- Zinc plated, steel fasteners

DESCRIPTION	MATERIAL	RETAIL PACK	PACK SIZE
Top Post	Lead, 1 pos., 1 neg.	82-9620	1 pair

TOP POST – 3 WAY TERMINAL



82-9620

BATTERY QUICK DISCONNECT

- 1/4" turn of the knob disconnects battery power
- Lead-free
- Copper; brass plated with zinc plated steel fasteners

DESCRIPTION	RETAIL PACK	PACK SIZE
Top Post, Negative	82-9595	1
Side Terminal, Universal	82-9596	1

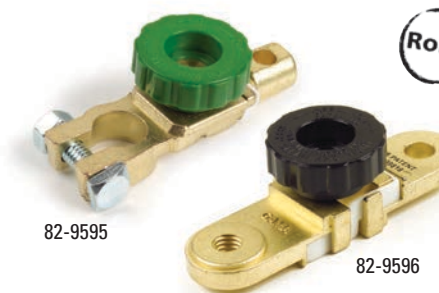

82-9595

82-9596

CONVERSION CONNECTORS

STUD-TO-TOP POST



84-9130

- Converts stud terminal battery to top post
- Polarity specific for exact fit
- 3/8" – 16 threaded steel insert and nylon lock ring provide superior electrical and mechanical integrity
- 3/4" hex base permits precise torquing

DESCRIPTION	SIZE	MATERIAL	RETAIL PACK	PACK SIZE	BULK PACK	PACK SIZE
Stud to Top Post	3/8"-16	Lead; die-cast steel	82-9130	1 pair	84-9130	5 pair

CONVERSION CONNECTORS

SIDE TERMINAL-TO-TOP POST



84-9131

- Permits top terminal cable connection to side terminal battery
- Stud head resists over-torque and improves conductivity; zinc-plated stud resists corrosion
- Polarity-specific for exact fit; oversize polarity signs molded in

DESCRIPTION	SIZE	MATERIAL	RETAIL PACK	PACK SIZE	BULK PACK	PACK SIZE
Top Post to Side Terminal	3/8"	Lead; die-cast steel	82-9131	1 pair	84-9131	5 pair
Negative					84-9610	5
Positive					84-9611	5

TERMINAL CONNECTORS

TOP POST-TO-SIDE



84-9132

- Permits side terminal cable connection to top terminal battery
- Polarity-specific for exact fit on posts; polarity signs molded in
- Lead construction – zinc plated hardware resists corrosion

DESCRIPTION	SIZE	MATERIAL	RETAIL PACK	PACK SIZE
Top Post to Side Terminal	3/8"	Lead; zinc-plated steel fasteners	82-9132	1 pair

PROTECTIVE WASHERS



84-9624

- Extends the life of the battery, connectors and hardware
- Easy to assemble

DESCRIPTION	PACK SIZE	PART #
Top Post Terminal	2	82-9623
Top Post Terminal	100	84-9624

FASTENER HARDWARE

- Complete selection of standard and heavy-duty battery-related hardware
- Meets OEM and SAE specifications



DESCRIPTION	SIZE	MATERIAL	RETAIL PACK	PACK SIZE	BULK PACK	PACK SIZE
Bolt, square head & nut	5/16" - 18 x 1 3/8"	Steel; zinc-plated	82-9183	2	84-9183	25
Bolt, square head & shoulder nut	5/16" - 18 x 1 3/8"	Steel; tin-plated	—	—	84-9289	25
Nut, closed cap for Group 31	3/8" - 16	Stainless Steel	82-9184	1	84-9184	25
Nut, flange	3/8" - 16	Steel; zinc-plated	—	—	84-9445	10
Bolt, side terminal; single power lead	3/8" - 16 x 13/32"	Steel; zinc-plated	82-9216	2	84-9216	25
Bolt, side terminal; dual power lead	3/8" - 16 x 1"	Steel; zinc-plated	82-9217	2	84-9217	25
Shim, battery post		Lead	—	—	84-9593	25
Spacer, for dual power lead, side terminal bolt		Lead	—	—	84-9612	10

ACCESSORY ADAPTER NUTS

- Connects power accessories directly to battery
- Fits standard battery bolt
- For post-terminal applications



DESCRIPTION	SIZE	MATERIAL	PACK SIZE	BULK PACK	PACK SIZE
Top terminal accessory post	5/16" - 18 x 9/16"	Brass; zinc-plated steel fasteners	1	84-9185	5
Side terminal extension bolt	3/8" - 16 x 13/32"	Brass; zinc plated fasteners	—	84-9599	5

POST-TERMINAL BRUSH

- Corrosion-resistant self-contained brush set
- Inner bristles clean post terminals
- Conical outer bristles clean cable connectors

PART #	PACK SIZE
84-9186	1



84-9186

BOOSTER CLAMPS – REPLACEMENT



- Jaws grip battery posts, studs & side terminals
- Insulated grips in both black & red
- For 1-3/0 gauges
- 3 coil spring, over 50 lbs of clamping pressure
- Solid copper clamps weigh over 3/4 lb.
- 5/16" – 18 nut & bolt included

RATING	JAW TYPE	DESCRIPTION	GRIP COLOR	PACK	PART #
400 AMP	Standard Jaws	Commercial grade	Red & Black	Pair	84-9280
500 AMP	Parrot Jaws	Industrial grade	Red & Black	Pair	84-9281
900 AMP	Parrot Jaws	Industrial grade	Red	1	84-9321
900 AMP	Parrot Jaws	Industrial grade	Black	1	84-9322
900 AMP	Parrot Jaws	Industrial grade	Red & Black	Pair	84-9630

BATTERY CABLE CONNECTORS



PLUG-IN STYLE

- Color coded ends help identify different voltages and will prevent mismatching power supply to the electrical output
- Comes complete with 1 housing and 2 contact terminals
- Housings mate together with the same color plug and receptacle – simply rotate connector 180° and plug similar part numbers together
- Available in 50, 175 and 350 AMP ratings for use up to 600 volt AC or DC

RATING	TYPE	GAUGE	COLOR	PACK	PART #
50 AMP	Plug-In End	12-10	Red	1	84-9680
50 AMP	Plug-In End	12-10	Grey	1	84-9627
50 AMP	Plug-In End	6	Red	1	84-9626
50 AMP	Plug-In End	6	Grey	1	84-9631
175 AMP	Plug-In End	4	Red	1	84-9681
175 AMP	Plug-In End	4	Blue	1	84-9551
175 AMP	Plug-In End	4	Grey	1	84-9632
175 AMP	Plug-In End	2	Red	1	84-9682
175 AMP	Plug-In End	2	Blue	1	84-9487
175 AMP	Plug-In End	2	Grey	1	84-9633
175 AMP	Plug-In End	1/0	Red	1	84-9628
175 AMP	Plug-In End	1/0	Blue	1	84-9683
175 AMP	Plug-In End	1/0	Grey	1	84-9634
350 AMP	Plug-In End	2/0	Red	1	84-9482
350 AMP	Plug-In End	2/0	Blue	1	84-9684
350 AMP	Plug-In End	2/0	Grey	1	84-9485

BATTERY CABLE CONNECTORS



PROTECTIVE CAPS – PLUG-IN STYLE

- Black protective caps cover the connector from weather and chemicals when not in use
- Available in three sizes

RATING	TYPE	DESCRIPTION	GRIP COLOR	PACK	PART #
50 AMP	Plug-In End	Fits 50 AMP housings	Black	1	84-9621
175 AMP	Plug-In End	Fits 175 AMP housing	Black	1	84-9456
350 AMP	Plug-In End	Fits 350 AMP housings	Black	1	84-9622

- Jaws accommodate up to 3/4"
- Excellent for test equipment
- Use for OEM repair and custom build
- Color-coded vinyl boots

RATING	JAW TYPE	DESCRIPTION	GRIP COLOR	RETAIL PACK	PACK
75 AMP	Clamp style	Industrial grade	Red	84-4997	1
75 AMP	Clamp style	Industrial grade	Black	84-4998	1
75 AMP	Clamp style	Industrial grade	Red & Black	84-4999	Pair
50 AMP	Clamp style	Industrial grade	Red	84-5002	1
50 AMP	Clamp style	Industrial grade	Black	84-5003	1
50 AMP	Clamp style	Industrial grade	Red & Black	84-5000	Pair

HEAVY DUTY CHARGING CLIPS



- For test/charge applications
- Jaws accommodate up to 3/4"

RATING	JAW TYPE	JAW SPREAD	RETAIL PACK	PART #	BULK PACK	PACK
10 AMP	Standard Jaw	7/16"	2	82-9540	84-9540	25
25 AMP	Standard Jaw	3/4"	2	82-9543	84-9543	25
50 AMP	Standard Jaw	1"	2	82-9544	84-9544	25

TEST CLIPS



- Jaws accommodate up to 5/16"

DESCRIPTION	INSULATED	COLOR	PART #	PACK
Test Lead, 10', 18 GA	Yes	Red	84-9615	1
Test Lead, 10', 18 GA	Yes	Black	84-9616	1
Test Lead, 2 1/2', 16 GA	Yes	Red & Black	84-9613	1 Pair
Alligator Clip	No	Red	84-5005	1
Alligator Clip	No	Black	84-5004	1

ALLIGATOR CLIPS & TEST LEADS



- Protective boots for Alligator Clips

DESCRIPTION	COLOR	RETAIL PACK	PACK SIZE	BULK PACK	PACK
Protective boots for Alligator Clips	Red & Black	82-9614	1 Pair	84-9614	5 Pair

ALLIGATOR CLIP BOOTS





BOOSTER CABLES



84-9550

- Cable construction of 100% fine-stranded copper conductors
- Tangle-free design remains flexible even in cold weather
- 1 & 2 Gauge includes Thermoplastic Elastomer (TPE) jacketing
- 4, 6 & 8 Gauge includes Polyvinyl chloride (PVC) jacketing
- All booster cables are supplied in a retail storage box
- Additional gauges and lengths available as special order
- 175A plug in ends for 84-9279 and 84-9496

LIGHT DUTY

GAUGE	JAW TYPE	JAW RATING	LENGTH	CABLE COLOR	JACKET	PART #
8 GA	Standard Jaws	200 AMP	12'	Yellow & Black	PVC	84-9550

MEDIUM DUTY – COMMERCIAL GRADE

GAUGE	JAW TYPE	JAW RATING	LENGTH	CABLE COLOR	JACKET	PART #
6 GA	Standard Jaws	500 AMP	16'	Orange & Black	PVC	84-9472
4 GA	Standard Jaws	500 AMP	16'	White & Black	PVC	84-9331
4 GA	Standard Jaws	500 AMP	20'	White & Black	PVC	84-9276
4 GA	Parrot Jaws	600 AMP	20'	White & Black	PVC	84-9277

MEDIUM DUTY, PLUG IN CONNECTOR – COMMERCIAL GRADE

GAUGE	JAW TYPE	JAW RATING	LENGTH	CABLE COLOR	JACKET	PART #
4 GA	Std. Jaws & Plug-In	500 AMP	20'	White & Black	PVC	84-9279
4 GA	Plug-In w/ 3/8" lugs	175 AMP	5'	White & Black	PVC	84-9496

HEAVY DUTY – INDUSTRIAL GRADE

GAUGE	JAW TYPE	JAW RATING	LENGTH	CABLE COLOR	JACKET	PART #
2 GA	Parrot Jaws	600 AMP	20'	Red & Black	TPE	84-9278
1 GA	Standard Jaws	500 AMP	12'	Grey & Black	TPE	84-9484
1 GA	Standard Jaws	500 AMP	16'	Red & Black	TPE	84-9477
1 GA	Standard Jaws	500 AMP	20'	Grey & Black	TPE	84-9476
1 GA	Parrot Jaws	900 AMP	25'	Grey & Black	TPE	84-9567

BOOSTER CABLE

TWIN CONDUCTOR



- Make up your own booster cables
- Combine with heavy duty clamps for superior charging power
- Can be used with SB type connectors for plug in convenience
- Ideal for tarps system (dump truck / dump trailer)
- Insulation stays flexible in cold weather; bonded cable resists tangling
- 100% fine-stranded copper meets SAE J1127 specifications
- Temperature rated to -40°F (-40°C); rated @ 60V or less

GAUGE	OUTSIDE DIAMETER	COLOR	LENGTH	PART #
8 GA NEW	.320" x .700"	Black & Yellow	1,500'	82-5759-1500
6 GA	.360" x .780"	Black & Orange	100'	82-5760
6 GA NEW	.360" x .780"	Black & Orange	1,200'	82-5760-1200
4 GA	.410" x .880"	Black & White	100'	82-5761
4 GA NEW	.410" x .880"	Black & White	500'	82-5761-500
2 GA	.450" x .960"	Black & Red	100'	82-5762

LIFT GATE – CHARGING PLUGS & SOCKETS

- Designed for lift gate applications and as an alternative power source
- Solid brass pin terminals for best conductivity
- 2, 1/2" mounting holes; stainless steel spring
- Terminals accepts 4 gauge cable
- 200 AMP heavy die-cast construction

SOCKET

PART #	SOCKET #	DESCRIPTION	MATERIAL
82-1041	2	Socket – Dual Pole	Zinc Die-Cast
82-0851	1	Socket – Single Pole	Zinc Die-Cast
82-2144		Socket Boot	Rubber

PLUG

PART #	PLUG #	DESCRIPTION	MATERIAL
82-1042	2	Plug & Spring – Dual Pole	Zinc Die-Cast
82-0852	1	Plug & Spring – Single Pole	Zinc Die-Cast

PLUG & SOCKET COMBO

PART #	PLUG/SOCKET#	DESCRIPTION	MATERIAL
82-0950	1	Plug & Socket – Single Pole	Zinc Die-Cast



82-1041

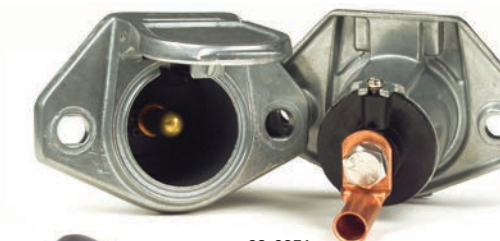

82-0851

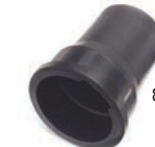

82-2144



82-1042

82-0852

VERTICAL PIN

DUMP TRUCK & TARP TRAILER PLUGS & SOCKETS

- Designed for dump truck, tarp and grain trailer applications; also alternative power source
- Solid brass pin terminals for best conductivity
- 2, 1/2" mounting holes; stainless steel spring
- Terminals accepts 4 gauge cable(s)
- 200 AMP heavy die-cast construction
- Vertical pin plug/socket = set screw termination

SOCKET

PART #	SOCKET #	DESCRIPTION	MATERIAL
82-1041V NEW	2	Socket – Dual Pole	Zinc Die-Cast
82-2144		Socket Boot	Rubber

PLUG

PART #	PLUG #	DESCRIPTION	MATERIAL
82-1042V NEW	2	Plug & Spring – Dual Pole	Zinc Die-Cast



82-1041V



82-2144



82-1042V

MOLDED BATTERY HARNESSSES

"BEST"



- 100% fine stranded copper conductor
- 2/0 GA, PVC jacketed starter cable
- Meets SAE J1127 specifications
- Designed to connect 2, 3 or 4 batteries
- Red and Black (+/-) option for easy polarity identification
- Protective caps protect contacts and prevent corrosion
- Precision molded provide a maintenance free seal

CENTRE TO CENTRE DIMENSION	POLARITY	PACK SIZE	PART #
7"	Negative	1	84-9582
7"	Positive	1	84-9583
14"	Negative	1	84-9584
14"	Positive	1	84-9585
21"	Negative	1	NEW 84-9586
21"	Positive	1	NEW 84-9587

QUICKLINK® STUD BATTERY HARNESSSES

"BETTER"



- 100% fine stranded copper conductor
- 2/0 GA, welding cable provides extreme flexibility in colder temperatures
- Includes high-end locking, anti-rotational lug ends to ensure a tight fit and a superior connection
- Ideal for truck, farm, construction and automotive applications

CENTRE TO CENTRE DIMENSION	POLARITY	TYPICAL BATTERY LAYOUT	PACK SIZE	PART #
8 1/2"	Negative	Side-By-Side	1	84-9304
8 1/2"	Positive	Side-By-Side	1	84-9305
12"	Negative	Side-By-Side	1	84-9420
12"	Positive	Side-By-Side	1	84-9421
17"	Negative	End-To-End	1	84-9306
17"	Positive	End-To-End	1	84-9307

TIN PLATED STUD BATTERY HARNESSSES

"GOOD"



- 100% fine stranded copper conductor
- 2/0 GA, welding cable provides extreme flexibility in colder temperatures
- Tin plated copper tube lug connections

CENTRE TO CENTRE DIMENSION	POLARITY	TYPICAL BATTERY LAYOUT	PACK SIZE	PART #
8 1/2"	Negative	Side-by-Side	1	84-9690
8 1/2"	Positive	Side-by-Side	1	84-9691
12"	Negative	Side-by-Side	1	84-9692
12"	Positive	Side-by-Side	1	84-9693
17"	Negative	End-to-End	1	84-9694
17"	Positive	End-to-End	1	84-9695

STUD BATTERIES – LUG TO LUG – BATTERY TO GROUND OR STARTER

CENTRE TO CENTRE DIMENSION	DESCRIPTION	GAUGE	PACK SIZE	PART #
10"	Lug to Lug, 3/8"- 3/8"	2/0 GA	1	84-9467
15"	Lug to Lug, 3/8"- 3/8"	2/0 GA	1	84-9470
20"	Lug to Lug, 3/8"- 3/8"	2/0 GA	1	84-9473



CENTRE TO CENTRE DIMENSION	POLARITY	GAUGE	PACK SIZE	PART #
13 5/8"	Negative	2/0 GA	1	84-9274
13 5/8"	Positive	2/0 GA	1	84-9275

TOP POST-TO-POWER TAKE OFF POST



- Designed for connection of 2 batteries to achieve additive voltage
- Premium quality synthetic rubber insulated copper welding cable enables easy routing & cold weather flexibility

CENTRE TO CENTRE DIMENSION	DESCRIPTION	GAUGE	PACK SIZE	PART #
12"	Offset	1 GA	1	84-9402
8"	Offset	1 GA	1	84-9401
8"	Offset	2/0 GA	1	84-9403

BATTERY JUMPERS

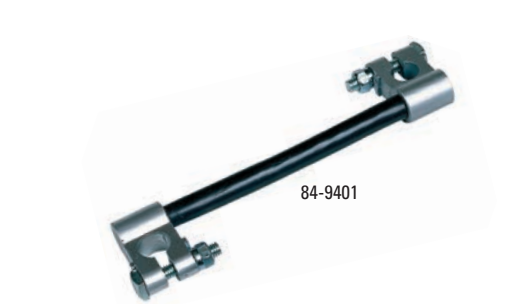

PRE-MADE LENGTHS

- 3/8" Clamp-to-Lug or Lug-to-Lug styles
- Light to medium duty, marine and automotive applications
- Corrosion-resistant tin plating

CENTRE TO CENTRE DIMENSION	DESCRIPTION	PACK SIZE	4 GAUGE PART #	2 GAUGE PART #
9"	Clamp to Lug	1		84-9239
9"	Lug to Lug	1	84-9577	
13"	Clamp to Lug	1		84-9240
13"	Lug to Lug	1	84-9559	
18"	Lug to Lug	1	84-9465	
19"	Clamp to Lug	1		84-9579
24"	Clamp to Lug	1		84-9464

BRAIDED GROUND STRAP





BATTERY CABLES

PRE-MADE LENGTHS



84-9225

- Meet or exceed SAE specifications; ideal for OEM replacement
- 100% fine stranded copper wire with black PVC insulation
- Tinning of copper wire before casting ensures perfect bond between wire and connector
- Antimonial lead connectors resist corrosion; die-cast process seals copper wires from acid fumes and corrosive salts
- Universal polarity top post connector
- Light duty trucks, vans and recreational vehicles (R.V.)
- Standard 3/8" stud hole

TOP POST CABLES

CENTRE TO CENTRE DIMENSION	PACK SIZE	4 GAUGE PART #	1 GAUGE PART #
10"	1	84-9224	
12"	1	84-9225	84-9241
14"	1	82-7014	
15"	1	84-9226	
16"	1	84-9227	84-9242
19"	1	84-9230	84-9243
21"	1		84-9503
22"	1	84-9228	
24"	1	84-9231	
25"	1	82-7025	
27"	1	84-9232	84-9244
30"	1	84-9233	84-9245
32"	1	84-9234	
36"	1	84-9229	84-9246
36"	1 RED		84-9571
37"	1	84-9235	
41"	1		84-9247
42"	1	84-9236	
48"	1	84-9237	84-9248
48"	1 RED		84-9572
53"	1	82-7053	
60"	1	84-9238	
65"	1		84-9510
72"	1	82-7072	

SIDE TERMINAL CABLES

- 3/8"- 16 x 13/32" bolts
- 1/2" hex head bolt

CENTRE TO CENTRE DIMENSION	DESCRIPTION	PACK SIZE	4 GAUGE PART #
15"	Side Terminal	1	84-9249
25"	Side Terminal	1	84-9250
35"	Side Terminal	1	84-9251
45"	Side Terminal	1	84-9252
55"	Side Terminal	1	84-9253
65"	Side Terminal	1	84-9254



84-9571



84-9249

SWITCH-TO-STARTER CABLES

CENTRE TO CENTRE DIMENSION	PACK SIZE	4 GAUGE PART #	1 GAUGE PART #
10"	1	84-9255	84-9505
15"	1	84-9256	84-9262
18"	1	84-9257	84-9382
19"	1		84-9388
24"	1	84-9258	84-9506
25"	1		84-9263
30"	1	84-9504	
33"	1	84-9259	
35"	1		84-9264
36"	1	84-9260	
40"	1	84-9261	



84-9256

SOLDER SLUGS AND FLUX

- Pre-measured solder slugs for quick and easy battery cable soldering
- Improves your electrical connection by filling in any contact irregularities
- Color coded to industry standards
- Gauges 6 through 4/0
- Melting temperature rating 182°C (361°F)

CABLE GAUGE	COLOR CODE	PACK SIZE	PART #
6	Grey	25	84-9600
4	Grey	25	84-9601
2	Green	25	84-9602
1	Pink	25	84-9603
1/0	Black	25	84-9604
2/0	Orange	25	84-9605
3/0	Purple	25	84-9606
4/0	Yellow	25	84-9607
Solder Flux	Clear	2oz.	84-9608



84-9606

84-9608

BATTERY TERMINAL SOLDER SLUG KIT

- Kit contains 48 pieces of heat shrink tubing, solder slugs and flux
- Ideal kit for any repair garage, mechanic or installer
- Provides superior protection from corrosion
- Improves your electrical connection by filling in any contact irregularities
- Color coded to industry standards
- Solder slugs melting temperature rating 182°C (361°F)

83-6532



83-6532

MASTER BATTERY DISCONNECT SWITCH



82-2103

- Truck, Automotive, Marine, Off-Road and R.V. applications
- For battery circuit (82-2103, 82-2233); for alternator or generator field circuit (82-2155)
- 3/4" & #10-32 copper alloy stud terminals with hex nuts, lock washers included
- Large die cast lever for ease of operation; mounting stem 1/2" long x 3/4" dia.
- Fits panel up to 1/4" thick; 10,000 life cycle; 6-36V DC
- Includes faceplate
- Faceplate replacement for 82-2103 (82-2157)
- Meets U.L. #558 (82-2103)

DISCONNECTS ALL CIRCUITRY TO REDUCE THE POSSIBILITY OF THEFT / ACCIDENTAL ELECTRICAL FIRES

PRODUCT RATING

Continuous Rating (Make/Break), Large Studs – 180 AMP @ 6-36V DC; 1,000 AMP – in rush (82-2103)

Continuous Rating (Make/Break), Large Studs – 180 AMP @ 6-36V DC (82-2233)

Intermittent Rating (Carrying), Large Studs – 1800 AMP @12V DC; 1 cycle = 4 seconds on/20 minutes off)



82-2157

PART #	POSITION	RATED	TYPE	TERMINATION	DIMENSIONS
82-2103	Off/On	12V	S.P.S.T.	2, 3/8" stud terminals ground w/ faceplate	4 3/8" L x 2 5/8" Dia.
82-2233 NEW	Off/On	24V	S.P.S.T.	2, 1/2" stud terminals ground w/ faceplate	4 3/8" L x 2 5/8" Dia.



82-2155

DESIGNED TO BREAK ALTERNATOR GENERATOR CIRCUIT PRIOR TO BATTERY CIRCUIT DISCONNECT

PRODUCT RATING

Continuous Rating (Make/Break), Large Studs: 180 AMP, Small Studs: 20 AMP @ 6-36V DC

Intermittent Rating (Carrying), Large Studs: 1,000 AMPs (20 sec. "On" – 5 Minutes "Off")

PART #	POSITION	RATED	TYPE	TERMINATION	DIMENSIONS
82-2155	Off/On	12V	D.P.S.T.	4 stud terminal ground	4 1/8" L x 2 5/8" Dia.

BATTERY ISOLATOR SWITCH



82-2104

- Prevents unauthorized use
- Eliminates battery discharge
- Waterproof body with removable key and protective cap
- Rated at 500 AMPs at 12V

82-2104

- Protects alternator and electrical system from shorts
- Reduces the risks of battery explosion caused by sparks
- High temperature PVC construction rated at 90°C (190°F)
- Color-coded for easy polarity identification
- Conforms to SAE J1128 dielectric specifications, meets USCG requirements

STRAIGHT CLAMP

FITS GAUGES	COLOR	PACK	PART #
1 & 2	Black	5	84-9140
1 & 2	Red	5	84-9141
1/0 & 2/0	Black	5	84-9142
1/0 & 2/0	Red	5	84-9143

STRAIGHT CLAMP SNAP ON FEATURE

FITS GAUGES	COLOR	PACK	PART #
6 & 4	Black	5	84-9138
6 & 4	Red	5	84-9139
1 & 2	Black	5	84-9136
1 & 2	Red	5	84-9137

AUTOMOTIVE LUG

FITS GAUGES	COLOR	PACK	PART #
1 & 2	Black	5	84-9150
1 & 2	Red	5	84-9151
1/0 - 2/0	Black	5	84-9152
1/0 - 2/0	Red	5	84-9153

TAB INSULATOR

FITS GAUGES	TERMINAL O.D.	COLOR	PACK	PART #
8-2	0.73"	Red	5	84-9323
8-2	0.73"	Black	5	84-9324
2-2/0	1.03"	Red	5	84-9327
2-2/0	1.03"	Black	5	84-9328
3/0-4/0	1.37"	Red	5	84-9325
3/0-4/0	1.37"	Black	5	84-9326

BATTERY TERMINAL PROTECTORS



84-9140

84-9141



84-9138

84-9139



84-9150

84-9151



84-9324

84-9323



BRUTE™ HAMMER CRIMPER



84-9087

- Inexpensive, simple crimping tool
- Use with hammer or vise
- Crimps 8- 4/0 gauge connectors
- Spring loaded pin locks in "up" position for loading connector and cable
- Pin is then released to hold connector securely during crimping
- 6 month limited warranty

CONNECTOR CABLE RANGE	PART #
8-4/0 GA	84-9087

CUB™ CRIMPER



84-9080

- Light-medium duty applications
- Adjustable crimp dies crimp all major lugs, connectors and splices
- Insulated grips
- One year limited warranty

OVERALL LENGTH	CONNECTOR CABLE RANGE	PART #
15"	8-1 GA	84-9080

HEXCRIMP™



84-9082

84-9085

- Medium to heavy duty applications
- Properly crimps copper, tin-plated, die cast and Magna lug splices and connectors
- Adjustable dies can crimp 8 to 250 MCM cable range
- 26" long with insulated handles for comfort
- 2 year limited warranty
- Made in North America



PART #	DESCRIPTION
84-9082	Hand Held
84-9085	Bench Mount
84-9084	Replacement Dies & Hardware (for 84-9082)

ROTARY CABLE SLITTER/STRIPPER TOOL

HEAVY DUTY



83-6515

- Slits & strips round battery & trailer cables
- Can strip 8 to 4/0 GA wire, battery and trailer cables
- Self-adjusting cutting depth
- Makes a clean strip without damaging wire strands
- Blade swivels for longitudinal/spiral cuts
- Ergonomic design



PART #	DESCRIPTION
83-6515	Heavy Duty Rotary Cable Slitter / Stripper Tool

- Cuts cable up to 2/0 gauge
- Fits any toolbox
- Forged steel with insulated grips
- 6 month limited warranty



9" CABLE CUTTER

84-9088

OVERALL LENGTH	CONNECTOR CABLE RANGE	PART #
9"	up to 2/0 GA	84-9088

- Cuts cables 22 GA to 250 mcm (6/0 GA)
- 22" handle for easy cutting
- 1075 Carbon steel blade, hardened for long life; can be sharpened
- 6 month limited warranty
- Made in North America

PART #	DESCRIPTION
84-9089	Hand Held
84-9090	Bench Mount

22" CABLE CUTTER



84-9089



84-9090

FIELD REPAIR KIT WITH HEXCRIMP™

- Contains components (except cable) needed to build or repair 2/0 battery cables
- The carrying case is made of steel, finished in corrosion resistant baked grey enamel

PART #	DESCRIPTION	RE-ORDER PART #
84-9290	Field Repair Kit- Includes:	
	1 HexCrimp™ Tool – 8 gauge - 250 mcm	84-9082
	1 9" Cutter – up to 2/0 cables	84-9088
	5 2/0 straight clamp – positive	84-9059
	5 2/0 straight clamp – negative	84-9058
	2 2/0 flag clamp – positive	84-9098
	2 2/0 flag clamp – negative	84-9097
	5 2/0 starter/ground lug – 3/8" hole	84-9110
	5 2/0 starter/ground lug – 1/2" hole	84-9111
	5 Terminal Protector straight – black	84-9142
	5 Terminal Protector straight – red	84-9143
	2 Terminal Protector flag – black	84-9144
	2 Terminal Protector flag – red	84-9145
	2 3/4" Heat shrink tubing 6" – Black 3:1	84-4003
	2 3/4" Heat shrink tubing 6" – Red 3:1	84-6103



84-9290

BATTERY BOXES

BATTERY BOXES FOR 6-VOLT, GC2 AND 4D BATTERIES

Growing demand for more power and deeper cycles has led to wider use of GC2 and 4D batteries in recreational vehicles, boats, and small alternative energy applications. Our Battery Box line allows you to set up the configuration that works best for your installation, whether it is single batteries, or dual batteries side by side or end-to-end.

Larger boxes use thumb screws to retain the covers and have foot pads to allow mounting options in low clearance environments like sailboats and campers.



Construction



Marine



RV

SINGLE & DUAL

- Rugged heavy wall polyethylene construction
- Impervious to acid, gasoline, oil and solvents
- Flame retardant
- Cold temperature impact resistant to -30°F (-34°C)
- Heat stable -30°F to +200°F (-34°C to +93°C)
- Single box holds ONE 6-Volt battery
- Dual box holds TWO 6-Volt batteries
- Depending on your space requirements, use two boxes side-by-side, end-to-end or use a dual box
- Dual box is molded in black

PART #	GROUP SIZE	TYPICAL BATTERIES IN ARRAY	BOX COLOR	INSIDE DIMENSIONS			OUTSIDE DIMENSIONS			MOUNTING BRACKET
				LENGTH	WIDTH	HEIGHT	LENGTH	WIDTH	HEIGHT	
84-9660	6-Volt/GC2	1	Black	10-3/4" (27.3 cm)	7-1/4" (18.4 cm)	12-1/4" (31.1 cm)	13-1/2" (34.3 cm)	9-1/4" (23.5 cm)	13" (33 cm)	-
SIDE BY SIDE										
84-9661	Dual 6-Volt/GC2	2	Black	15" (38.1 cm)	11" (27.9 cm)	13" (33 cm)	20" (50.8 cm)	14-1/2" (36.8 cm)	14-1/2" (36.8 cm)	(2 Included)
END TO END										
84-9425	Dual 6-Volt Single 4D GC2	2	Black	21-5/8" (55 cm)	9-1/2" (24.1 cm)	11-1/2" (29.2 cm)	26-3/4" (68 cm)	14" (35.6 cm)	12-3/4" (32.4 cm)	(2 Included)



Single 6-Volt
84-9660



Dual 6-Volt side-by-side, black
84-9661



Dual 6-Volt end-to-end
84-9425

BATTERY BOXES

COMMERCIAL MARINE, RECREATIONAL VEHICLES, CONSTRUCTION MACHINERY, LARGER OFF-GRID, BACKUP POWER SYSTEMS

Big power requirements mean big batteries and big battery boxes. Our commercial boxes are used for 4D, 8D and other large arrays. These boxes traditionally have secured batteries on working boats and heavy construction equipment and now are found in larger residential and small commercial off-grid power systems.

With mounting options to accommodate a variety of installations, venting options and cable routing options including conduit mounting, these battery boxes have been carefully engineered to solve your battery security issues.



Construction



Heavy Duty



Marine

COMMERCIAL BOXES

- Rugged, durable, heavy wall construction
- Impervious to acid, gasoline, oil and solvents
- Heat stable to +200°F (+93°C)
- Cold temperature impact resistant to -30°F (-34°C)
- Flame retardant
- UV stabilized (Rating 6)
- 3-4 way cable channels molded into design
- Large entry ports for heavy duty cable
- Cover held firmly with convenient thumb screws, no special tools required
- Cover can be locked for protection and tamper resistance
- Vent holes in cover allow gases to escape, preventing dangerous hydrogen build up
- Accommodates variety of mounting options

PART #	TYPICAL GROUP SIZE	TYPICAL BATTERIES IN ARRAY	COLOR	INSIDE DIMENSIONS			OUTSIDE DIMENSIONS			MOUNTING BRACKET
				LENGTH	WIDTH	HEIGHT	LENGTH	WIDTH	HEIGHT	
84-9425	4D	1	Black	21-5/8" (55 cm)	9-1/2" (24.1 cm)	11-1/2" (29.2 cm)	26-3/4" (68 cm)	14" (35.6 cm)	12-3/4" (32.4 cm)	(2 Included)
84-9426	8D High	1	Black	21-5/8" (55 cm)	11-3/4" (29.8 cm)	13" (33 cm)	26-3/4" (68 cm)	16-1/2" (41.9 cm)	14" (35.6 cm)	(2 Included)
84-9664	Dual 8D End-to-End	2	Black	42-1/2" (108 cm)	12" (30.5 cm)	10-3/4" (27.3 cm)	49-1/2" (125.7 cm)	18-1/4" (46.4 cm)	12-1/4" (31.1 cm)	(Optional)
84-9665	Dual 8D Side-by-Side	2	Black	21-1/2" (54.6 cm)	23-1/2" (59.7 cm)	10-3/4" (27.3 cm)	27" (68.6 cm)	29" (73.7 cm)	12-1/4" (31.1 cm)	(2 Included)



4D
84-9425



8D high
84-9426



Dual 8D end-to-end
84-9426



Dual 8D side-by-side
84-9665

BATTERY BOXES



Mounting holes



Strap in use

AUTO, LIGHT TRUCK, MARINE & RV

Trilingual safety warning in English, French and Spanish



Vent holes allow gases to escape, preventing dangerous hydrogen build up

Cover

Larger wider cable ports for easy cable access



Heavy duty tie down strap kit is included with each box.

FITS ALL BATTERIES

- Fits all traditional battery group sizes
- Fits all new orbital or spiral celled, deep cycle, high performance batteries

NEW COVER

- Easy-on and easy-off
- Safe and secure
- Convenient, fast, durable

NEW MOUNTING HOLES IN HANDLE

- Use hold-down holes molded in to reinforced handles
- Use J-hooks, L-hooks, threaded rod or lag bolts
- Remove the lid while keeping the box secure

NEW TOUGHER MATERIAL

- Impact resistant to -30°F (-34°C)
- Heat stable to +200°F (+93°C)
- Meets U.S. Coast Guard Regulations 183.420 & ABYCE-10.7
- Impervious to acid, gasoline, oil and solvents
- Will not rust, UV protected

PART #	GROUP SIZE	INSIDE DIMENSIONS			OUTSIDE DIMENSIONS		
		LENGTH	WIDTH	HEIGHT	LENGTH	WIDTH	HEIGHT
84-9662	U1 Black	8" (20.3 cm)	5-1/4" (13.3 cm)	7-15/16" (20.1 cm)	10-3/4" (27.9 cm)	7-1/2" (19.1 cm)	8-1/2" (21.6 cm)
84-9424	24 Black	10-1/2" (26.7 cm)	7" (17.8 cm)	9-3/4" (24.8 cm)	13-1/2" (34.3 cm)	9-1/4" (23.5 cm)	10-1/4" (26 cm)
84-9427	27 Black	12-3/4" (32.4 cm)	7-1/4" (18.4 cm)	10" (25.4 cm)	16-1/8" (40.9 cm)	9-5/8" (24.4 cm)	10-7/8" (27.6 cm)
84-9423	Adjustable 24, 27, 31 Black	14-1/2" (36.8 cm)	7-1/4" (18.4 cm)	10-3/8" (26.3 cm)	17-3/4" (45.1 cm)	10-1/4" (26 cm)	10-7/8" (27.6 cm)
84-9422	Dual 27, 31	14-1/2" (36.8 cm)	15-1/2" (39.3 cm)	10-1/4" (26.0 cm)	19-1/4" (48.8 cm)	20" (50.8 cm)	11-7/8" (30.1 cm)



U1



24



27



24, 27, 31



Dual 27, 31

BATTERY HOLD-DOWNS

- New telescoping design
- Fiberglass-reinforced polypropylene is rust and corrosion-proof
- Non-conductive – eliminates hold-down as source of shorts
- Car, truck, bus, off-road, marine and recreational vehicle applications

PART #	DESCRIPTION	MIN/MAX EXTENSION	PACK SIZE
84-9288	Offset hold-down	5 1/2" - 9"	1
84-9320	Flush hold-down	8 5/8" - 14 3/4"	1
84-9480	Adjustable mount crossbar	6 7/8"	1



84-9320

84-9480

HOLD DOWN SETS – L & J STYLE

- Long thread accommodates all crossbar/frame designs including QuickHold® products
- "L" and "J" style bend eliminates any need to shift or remove battery
- Sold as pair; hardware included
- Use with battery tray below
- 4", 1/4"-20 thread

PART #	DESCRIPTION	LENGTH	PACK
84-9287	J bolt	8"	Pair
84-9286	J bolt	10"	Pair
84-9685 NEW	J bolt	12"	Pair
84-9285	L bolt	10"	Pair



84-9285

84-9286

BATTERY TRAYS

BATTERY TRAYS

- Drain slots prevent fluid accumulation
- Ideal replacement for OEM-style trays
- Vinyl coated steel resists corrosion & cold climate cracking
- Also fits group 1, 2, 17, 22, 23, 42, 54, 55, 56, 72 & 74 batteries (84-9481)

PART #	DESCRIPTION	PACK
84-9481	11" for Group 24 size batteries	1
84-9629	GM base mount hold down	1



84-9481



84-9629

RESCUE® 2100



84-9657

PORTABLE POWER PACK

- 12/24V power, USB power outlet
- Dual 12-Volt 22AH high output AGM batteries
- Built-in, 1 AMP internal charger – CEC compliant
- Digital battery voltage gauge reads internal and external
- 12V power outlet; 500 AMP coated parrot clamps
- 2 gauge 62" 100% copper cables
- Work light and flasher, battery charging status
- Unit will not operate if polarity or voltage is set incorrectly
- Professional quality
- Crank/Peak: 12V 900/1600 Amps; 24V 500/1100 Amps
- 1 Year Warranty

PART #	GAUGE	LENGTH	BATTERY CAPACITY
84-9657	2	62"	Dual 22 AMP Hr.

RESCUE® 1800



84-9656

A WORKHORSE FOUND IN MORE ROADSIDE SERVICE VEHICLES

- Professional quality
- Dual 12-Volt 20AH AGM batteries
- 2 gauge 62" 100% copper cables
- LED battery charging status
- Polarity alarm; 500 AMP coated parrot clamps
- 12-Volt power outlet
- Internal battery gauge
- Work light and flasher
- Built in charger
- Crank/Peak: 12V 700/1500 Amps
- 1 Year Warranty

PART #	GAUGE	LENGTH	BATTERY CAPACITY
84-9656	2	62"	Dual 20 AMP Hr.

RESCUE® 900



84-9674

AUTOMOTIVE / POWERSPORTS: RELIABLE POWER DELIVERED WHEREVER AND WHENEVER YOU NEED IT

- 12-Volt 18AH AGM battery
- 6 gauge 27" 100% copper cables
- 12-Volt power outlet
- Built-in charger
- LED battery charging status
- Crank/Peak: 12V 400/900 Amps
- 1 Year Warranty

PART #	GAUGE	LENGTH	BATTERY CAPACITY
84-9674	6	27"	18 AMP Hr.

POWER PACK COMPARISON CHART

MODEL	PART #	VOLTAGE	STYLE	CABLE LENGTH	CABLE GAUGE	BATTERY (AH)	BATTERY STATUS	COMPRESSOR	INVERTER	USB PORT	SHIPPING WEIGHT
2100	84-9657	12/24V	Hand Carried	62" 157.5 cm	2	Dual 22 AMP Hour	Digital	No	No	Yes	40.0 lb 18.3 kg
1800	84-9656	12V	Hand Carried	62" 157.5 cm	2	Dual 20 AMP Hour	Analog	No	No	No	40.5 lb 18.5 kg
900	84-9674	12V	Hand Carried	27" 68.5 cm	6	18 AMP Hour	LED	No	No	No	25.0 lb 11.4 kg

- Perfect for lead-acid, flooded or sealed maintenance-free batteries (AGM, gel cell)
- Complete 4-step charging program (Initialization, Bulk Charge, Absorption Mode, Float Mode)
- Automatically switches to float/maintenance voltage after fully charging the battery
- Solid state two color LED indicates stage of charger
- Reverse polarity protected
- Dimensions: 3.3"L x 2.3"W x 1.9"H, 2 lbs
- Meets cUL, UL and CSA standards
- 5 Year Warranty

PART #	DESCRIPTION
021-0123-CA	Battery Tender – Junior, 0.75 AMPs @ 12v

- Spark Proof, Waterproof, Short Circuit Protected
- Reverse Polarity Protected
- Dimensions: 4.2"L x 2.8"W x 1.4"H, 2 lbs
- Meets UL and CE standards
- 3 Year Warranty

PART #	DESCRIPTION
022-0150-DL-WH	Battery Tender – Waterproof 800, 0.80 AMPs @ 12v

- Temperature compensated to ensure optimum charge voltage according to ambient temperature
- Automatically switches from full charge to float charging mode
- Battery Tender at 1.25 AMPs will charge as fast or faster than any 3 AMP charger
- Reverse Polarity Protection to ensure user safety – Red & Green Lights
- Complete 4-step charging program (Initialization, Bulk Charge, and Absorption Mode, Float Mode)
- Dimensions: 4.9"L x 3.3"W x 2.9"H, 3 lbs
- Meets cUL, CSA and UL Standards
- 10 Year Warranty

PART #	DESCRIPTION
021-0128-CA	Battery Tender – Plus, 1.25 AMPs @ 12v

- Ideal for AGM style batteries, Group 31 batteries, heavy duty applications
- These units are waterproof, vibration proof, mountable and include a safety timer
- Dimensions: 5.25"L x 5.0"W x 2.0"H, 4 lbs
- Meets UL Standards
- 2 Year Warranty

PART #	DESCRIPTION
022-0157-CA	Battery Tender – Power Tender Plus, 5.0 AMPs @ 12v
022-0158-CA	Battery Tender – Power Tender Plus, 2.5 AMPs @ 24v

BATTERY TENDER® JUNIOR



021-0123-CA

BATTERY TENDER® WATERPROOF 800



022-0150-DL-WH

BATTERY TENDER® PLUS



021-0128-CA

POWERTENDER PLUS



022-0157-CA

BATTERY CABLE – TYPE SGR



82-5703

- 100% Copper Cable
- Chlorinated Polyethylene (CPE) Jacket rated at -40°C (-40°F) to 90°C (194°F)
- Meets all SAE code J1127 specifications
- All battery cable is spooled
- 1000'+ custom size spools also available
- Rated @ 60 Volt

6 GAUGE

COLOR	25'	50'	100'
Black	82-5722	82-5725	82-5726
Red	82-6722	82-6725	82-6726

4 GAUGE

COLOR	25'	50'	100'
Black	82-5714	82-5713	82-5712
Red	82-6717	82-6713	82-6712

2 GAUGE

COLOR	25'	50'	100'
Black	82-5711	82-5710	82-5709
Red	82-6718	82-6710	82-6709

1 GAUGE

COLOR	25'	50'	100'
Black	82-5708	82-5707	82-5706
Red	82-6719	82-6707	82-6706

1/0 GAUGE

COLOR	25'	50'	100'
Black	82-5705	82-5704	82-5703
Red	82-6720	82-6704	82-6703

2/0 GAUGE

COLOR	25'	50'	100'
Black	82-5702	82-5701	82-5700
Red	82-6721	82-6701	82-6700

3/0 GAUGE

COLOR	25'	50'	100'
Black	82-5723	82-5715	82-5733
Red	82-6723	82-6715	82-6733

4/0 GAUGE

COLOR	25'	50'	100'
Black	82-5743	82-5716	82-5753
Red	82-6743	82-6716	82-6753

GAUGE	OUTSIDE DIAMETER	STRANDS
6	.310"	7 x 19 x .0157"
4	.370"	7 x 27 x .0142"
2	.468"	19 x 16 x .0142"
1	.495"	19 x 21 x .0142"
1/0	.550"	19 x 26 x .0142"
2/0	.595"	19 x 21 x .0179"
3/0	.700"	19 x 35 x .0156"
4/0	.760"	19 x 54 x .0142"

- Ideal for use as an interconnection between batteries and a starter or as a ground in a vehicle
- Abrasion, salt and chemical resistant; good flame resistance
- Fine stranded copper conductor; made in North America
- Provides better flexibility than standard PVC starter cable
- Jacket rated at -50°C (-58°F) to 105°C (221°F)
- Rated @ 600V
- All welding cable is spooled

6 GAUGE NEW

COLOR	STRANDS	25'	100'
Black	273	82-5732	82-5734
Red	273	82-6732	82-6734

4 GAUGE NEW

COLOR	STRANDS	25'	100'
Black	427	82-5724	82-5735
Red	427	82-6727	82-6735

2 GAUGE NEW

COLOR	STRANDS	25'	100'
Black	651	82-5721	82-5736
Red	651	82-6728	82-6736

1 GAUGE NEW

COLOR	STRANDS	25'	100'
Black	840	82-5737	82-5738
Red	840	82-6746	82-6738

1/0 GAUGE NEW

COLOR	STRANDS	25'	100'
Black	1,044	82-5739	82-5740
Red	1,044	82-6739	82-6740

2/0 GAUGE NEW

COLOR	STRANDS	25'	100'
Black	1,308	82-5730	82-5731
Red	1,308	82-6730	82-6731

3/0 GAUGE NEW

COLOR	STRANDS	25'	100'
Black	1,653	82-5741	82-5742
Red	1,653	82-6741	82-6742

4/0 GAUGE NEW

COLOR	STRANDS	25'	100'
Black	2,071	82-5744	82-5745
Red	2,071	82-6744	82-6745

WELDING CABLE



82-5730



82-6730

GAUGE	OUTSIDE DIA.	STRANDING (.010" DIA)
6	.305"	266
4	.340"	392
2	.420"	644
1	.490"	784
1/0	.536"	1026
2/0	.593"	1254
3/0	.640"	1615
4/0	.715"	2052