

## LED SEALED BEAM REPLACEMENT HEADLAMP BULBS



### FEATURES & BENEFITS

- Designed to swap into existing housings that H6024 (90941-5) and H6054 (90951-5) currently fit into.
- Designed for a standard H4 connection, no additional wiring needed for vehicles featuring standard H4 wiring.
- Long lasting LEDs and impact resistant polycarbonate lens outperform OEM halogen and incandescent bulbs in longevity, light output and pattern.



90941-5

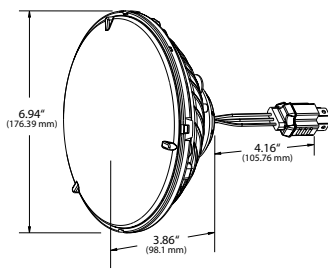

90941-5

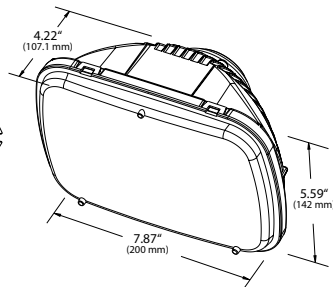

90951-5



90951-5

Part Number	FMVSS/SAE	Product Description	Low Beam Watt	High Beam Watt	Voltage (V)	Amperage (A)
90941-5 <span style="color: green;">NEW</span>	2D-1	Grote 7 LED Head Lamp	15	27	9-32	1.4 @12.8 low 2.13 @12.8 low
90951-5 <span style="color: green;">NEW</span>	2B-1	Grote 5/7 LED Head Lamp	21	33	9-32	1.59 @12.8 low 2.54 @12.8 high
94401-5 <span style="color: green;">NEW</span>	2A-1	Grote 4x6 LED Head Lamp Combination	18.84@12V 18.84@24V	18.84@12V 18.84@24V	9-32	1.57 @12V 0.77 @24V
94411-5 <span style="color: green;">NEW</span>	1A-1	Grote 4x6 LED Head Lamp High Beam	N/A	17.16@12V 16.08@24V	9-32	1.43 @12V 0.67 @24V
94421-5 <span style="color: green;">NEW</span>	2A-1	Grote 4x6 LED Head Lamp Low Beam	13.08@12V 12.72@24V	N/A	9-32	1.09 @12V 0.53 @12V

All figures listed are based on nominal voltage

### Accessories

Part Number	Description
68630	self-addressable pigtail for vehicles with non-standard H4 wiring

Materials	Certifications
Housing anodized aluminum, Lens uv-coated polycarbonate	7" lamp meets DOT, FMVSS, SAE standards for 2D-1
	5x7 lamp meets DOT, FMVSS, SAE standards for 2B-1

# Forward Lighting

Phares Utilitaires Faros Delanteros

**per-lux**  
BY **Grote**



64291-4

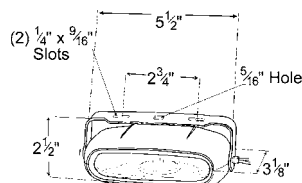
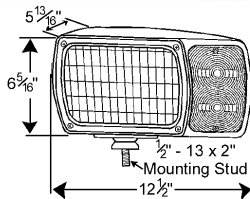

## PER-LUX® SNOWPLOW LAMPS

Resilient, polycarbonate housing and halogen sealed beam withstands hours of use at sub-zero temperatures • Features integrated parking and turn signal lights • Rubber shock mount and center mounting stud absorbs road shock • Optional 5-way Packard® Connector

### SEALED BEAM:

<b>64261-4</b>	Pair Pack
<b>64241</b>	LH
<b>64251</b>	RH

### SEALED BEAM WITH CONNECTOR:

<b>64291-4</b>	Pair Pack
<b>64271</b>	LH
<b>64281</b>	RH

Material: Polycarbonate  
 FMVSS: H, I2, P  
 Finish: Black  
 Bulb: H6545, Major - 65 Watt, 40,000 C.P./Minor - 45 Watt, 25,000 CP  
 Volts / Amps: 12V / 5.0/3.5A  
 Bulb: 1157, 32/3 CP; Volts / Amps: 12V / 2.1/.59A; Pigtail: 68680 (64291-4)  
 Lens: Yellow 90483

## SNOWPLOW LAMP KIT WITH UNIVERSAL WIRING HARNESS

Integrated turn signal/parking lamp lens • Vibration-dampening mounting system prolongs bulb life • Kit includes left and right side lamps, heavy-duty selector switch, wiring connectors, mounting hardware, and easy installation instructions

**63451-4** Pair Pack

### REPLACEMENT LAMP:

<b>63381</b>	LH
<b>63391</b>	RH

Material: Polycarbonate  
 FMVSS: H, I2, P  
 Finish: Black  
 Bulb: H6054, Major - 65 Watt/Minor - 35 Watt; Volts / Amps: 12V / 5/2.7A  
 Bulb: 1157, 32/2 CP; Volts / Amps: 12V / 2.1/.59A  
 Bulb: 1156, 32 CP; Volts / Amps: 12V / 2.1A  
 Lens: Yellow 93163

## SLIM-LINE HALOGEN FOG LIGHTS

Housing made of die-cast aluminum • Ion coated lens • Kit includes lamps, switch, wiring, and instructions • Not compliant for FMCSA 393.24(b) applications

**64371-5** Clear, Fog Lamp Kit **FOG** **RETAIL**

Material: Die-Cast Aluminum  
 FMVSS: F  
 Finish: Black  
 Bulb: H3, 55 Watt, 121 CP; Volts / Amps: 12V / 4.7A  
 Accessory: Bulb: 90861-5/90971-5  
 Lens: Clear 93131

## MINI HALOGEN FOG AND DRIVING LAMP KIT

Low-profile styling • High-impact nylon housing • Kit includes lamps, rocker switch and installation kit • Not compliant for FMCSA 393.24(b) applications

**64061-5** Clear, Driving Lamp Kit **FOG RETAIL**

Material: Nylon  
 Finish: Black  
 Bulb: H3, 55 Watt, 121 CP  
 Volts / Amps: 12V / 4.7A  
 Accessory: Bulb: 90861-5/90971-5



## HALOGEN FOG LAMP

Glass lens resists hazing • Aluminized reflector for increased brightness  
 • Black powder coated hardware • Industry-standard electrical connector  
 • Watertight design on the front of the lamp • Meets FMCSA 393.25 (b)

**63531** Black **FOG**

Material: Glass/Plastic Housing  
 FMVSS: F  
 Finish: Black  
 Bulb: H3, 55 Watt, 121 CP  
 Volts / Amps: 12V / 4.7A

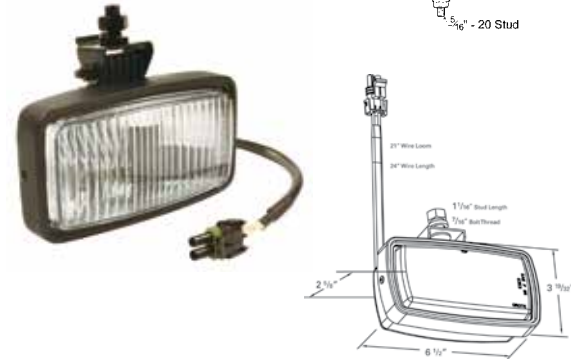

## SPORT AND UTILITY LAMP KIT

Rugged, high-impact plastic construction • Hardened glass lens  
 • Mounts above or below bumper • Kit includes lamps, rocker switch and installation kit • Meets FMCSA 393.25(b) applications

**64351-5** Clear, Fog Lamp Kit **FOG RETAIL**

**64401-5** Clear, Driving Lamp Kit **RETAIL**

Material: ABS  
 Finish: Clear  
 Bulb: H3, 55 Watt, 121 CP  
 Volts / Amps: 12V / 4.7A  
 Accessory: Bulb: 90861-5/90971-5



## PAR 56 7" HEADLAMP

7-inch headlamp • Includes sealed beam #6014 for 12-volt systems  
 • Ideal for many trucks, road maintenance vehicles, off-road equipment, in-plant vehicles, material handling trucks, mine cars, dune buggies, etc.

**64071** Black, Powder Coated

Material: Steel  
 Finish: Black  
 Bulb: 6014, PAR 56, 50 Watt/60 Watt, 25,000/32,000 CP  
 Volts / Amps: 12V / 4.7/3.9A



## ROUND OFF-ROAD LAMP

Rugged steel housing • Universal-swivel, rubber-cushioned mounting pedestal

**64481-5** Black **RETAIL**

**64501-5** Chrome **RETAIL**

Material: Steel  
 FMVSS: O  
 Finish: Chrome, Black  
 Bulb: H3, 100 Watt, 192 CP; Volts / Amps: 12V / 8.33A  
 Accessory: Bulb: 92701-5  
 Lens: Clear 93171



# Forward Lighting

Phares Utilitaires Faros Delanteros

**per-lux**  
BY **Grote**

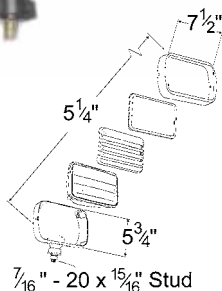
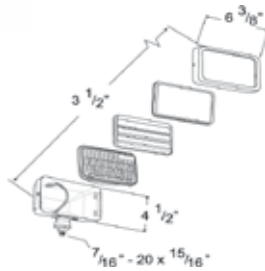
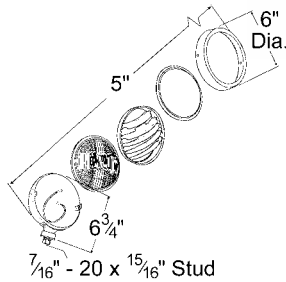

## PER-LUX® 200 SERIES FOG AND DRIVING LAMPS

Louvers direct the beam low to the road so reflected glare from fog, rain, or snow is safely avoided • Pierces 100 feet through the densest fog • Rugged stainless steel housing

### HALOGEN:

**02001-4** Clear, Fog / Driving Lamp, Swivel Mount, Pair Pack **FOG**

Material: Stainless-Steel  
Finish: Stainless  
Bulb: H7621-1, 20,000 CP  
Volts / Amps: 12V / 3.9A; 50 Watt  
Accessory: Springs for Sealed Beam Ret. For Swivel Mount Lamps 09510 (pair pack);  
Lens: Clear Glass 09561

## PER-LUX® 500 SERIES FOG AND DRIVING LAMPS

Pair Packs include wiring kits • All lamps come with swivel mount • Fog lamp beam pattern pierces through fog, rain, snow, or dust effectively, focused ahead and low to the road, and giving a side-to-side as well as forward illumination

### HALOGEN:

**05001-5** All Weather Louvered, H9421, Pair Pack, Stainless Steel **RETAIL**  
**05151** All Weather Louvered, H9421, Single, Stainless Steel **RETAIL**  
**05301-5** All Weather Louvered, H9421, Pair Pack, Powder Coated **RETAIL**  
**05041-5** Driving Lights, H9420, Pair Pack, Stainless Steel **RETAIL**  
**05051-5** Fog Lamps, H9415, Pair Pack, Stainless Steel **FOG RETAIL**

Material: Stainless Steel  
Finish: Stainless / Powder Coat  
Bulb: H9421 - 14,000 CP; Volts / Amps: 12V / 3.9A; 50 Watt  
Bulb: H9420 - 47,000 CP; Volts / Amps: 12V / 3.9A; 50 Watt  
Bulb: H9415 - 12,000 CP; Volts / Amps: 12V / 2.9A; 37.5 Watt  
Accessory: Springs for Sealed Beam 09510; Black Louver 09712  
Lens: Glass Lens Clear 09681  
Sealed Beam: All-Weather, Halogen, Sealed Beam Clear H9421  
Fog Lamp, Halogen, Sealed Beam Clear H9415

## PER-LUX® 600 SERIES FOG AND DRIVING LAMPS

Louvers direct the beam low to the road so reflected glare from fog, rain or snow is safely avoided • Pierces 100 feet through the densest fog • Rugged stainless steel housing • Pair packs come with wiring kits • Meets FMCSA 393.25(b) applications (except 06001-4 & 06013-4)

### INCANDESCENT

**06021-4** Clear, All-Weather Lamp, Swivel Mount, Pair Pack **FOG**

### HALOGEN:

**06001-4** Clear, All-Weather Lamp, Swivel Mount, Pair Pack  
**06201** Clear, All-Weather Lamp, Swivel Mount  
**06013-4** Yellow, All-Weather Lamp, Swivel Mount, Pair Pack

Material: Stainless Steel  
Finish: Stainless  
Bulb: #H7921-1, 23,900 CP; Volts / Amps: 12V / 3.9A; 50 Watt  
Bulb: #4921-1, 25,000 CP; Volts / Amps: 12V / 7.7A; 100 Watt  
Accessory: Black Louver 09802  
Lens: Clear, Glass 09781; Yellow, Glass 09793  
Sealed Beam: Clear, All-Weather, Incandescent 4921-1; Clear, All-Weather, Halogen 6006H



## PER-LUX® 700 SERIES FOG AND DRIVING LAMPS

Fog lamp beam pattern pierces through fog, rain, snow or dust effectively, focused ahead and low to the road giving side-to-side as well as forward illumination • Off-road spot lamps provide pure focused light that pierces far into the night for long distance viewing of a specific area, great for off-road and 4-wheel-drive applications • Off-road wide flood lamp applications provide wide illumination for RVs, motor-homes, tractors, utility, and off-road construction great for backing, loading, fueling, or troubleshooting

- Rugged stainless steel housing
- Pair packs come with wiring kit
- Meets FMCSA 393.25(b)- (except 07021-4 & 07031-4)

### INCANDESCENT:

**07001-4** Clear, All-Weather Lamp, Swivel Mount, Pair Pack **FOG**  
**07401** Clear, Fog Lamp, Rigid Mount **FOG**

### HALOGEN:

**07021-4** Clear, Spot Lamp, Swivel Mount, Pair Pack

Material: Stainless Steel  
 FMVSS: Street Legal (except for 07021-4, 07031-4)  
 Finish: Stainless  
 Bulb: #4912-1, 14,000 CP; Volts / Amps: 12V / 3.9A; 50 Watt  
 Bulb: #H7935-1, 175,000 CP; Volts / Amps: 12V / 3.9A; 50 Watt  
 Bulb: #H7921-1, 23,900 CP; Volts / Amps: 12V / 3.9A; 50 Watt  
 Sealed Beam: Clear, Fog, Incandescent 4912-1;  
 Clear, Spot, Halogen H7935-1

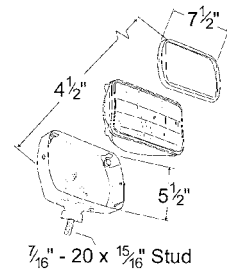

## PER-LUX® DOCKING LIGHT

Flush mounted • Multi-purpose docking/utility light

### HALOGEN:

**07803** Lamp w/ Stainless Steel Bezel

Material: Stainless Steel  
 Finish: Stainless  
 Bulb: H9406, 1,350CP  
 Volts / Amps: 12V / 3.9A; 50 Watt

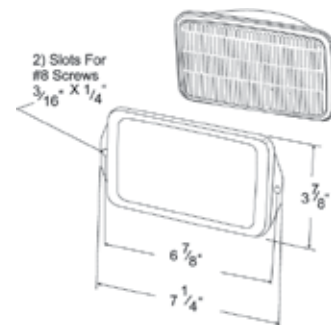



# Forward Lighting

Phares Utilitaires Faros Delanteros

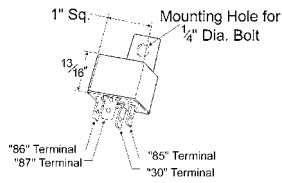

## FOG AND DRIVING LAMP RELAY

30 AMP relay • Guards against arcing and overloads

**44840-5** **RETAIL**

Volts / Amps: 12 V / 30A max

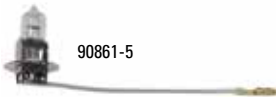

90861-5

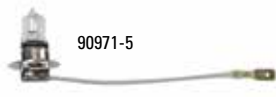

90971-5

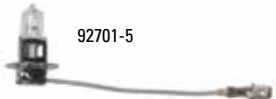

92701-5



90620

## REPLACEMENT 12-VOLT HALOGEN BULBS

Replacement bulb for auxiliary lights

**90861-5** 55 Watt, Bullet Terminal

**RETAIL**

**90971-5** 55 Watt, Spade Terminal

**RETAIL**

**92701-5** 100 Watt, Spade Terminal

**RETAIL**

**90620** 55 Watt, High Output

Bulb: 90861-5, 90971-5 - H3, 55 Watt, 121 CP; Volts / Amps: 12V / 4.7A

Bulb: 92701-5 - H3, 100 Watt, 187 CP; Volts / Amps: 12V / 7A

Bulb: 90620- H1, 55 Watt, 121 CP; Volts / Amps: 12V / 5.2A



91051



90901 - 24V

90900 - 12V

## REPLACEMENT 24-VOLT HALOGEN BULBS

**91051** 70 Watt, Spade Terminal

**24 VOLT**

**90901** 50 Watt, Standard Socket

**24 VOLT**

Bulb: 91051 - H3, 70 Watt, 135 CP; Volts / Amps: 24V / 2.7A

Bulb: 90901 - 50 Watt; Volts / Amps: 24V / 2A

### Electronic Characteristics

12/24 Volts, 1.5/0.75 Amps, 18 Watts  
Overvoltage Protection