

12

TRAILER WIRING & COMMUNICATIONS SYSTEMS

*SYSTÈMES DE COMMUNICATION ET
FILAGE DE REMORQUES*

*SISTEMAS DE ARNESES PARA
REMOLQUE / CAJA DE CONEXIÓN*

GROTE GUARDIAN® SMART SYSTEM

• REAL-TIME ALERTS

Get real-time alerts about your trailer lighting system sent straight to your smartphone or telematics system. Grote Guardian® samples at a rate of up to 100 times per second, measuring both voltage and current to determine when an event has occurred and let you know immediately.

• OPTION FOR A GATEWAY DATA NOTIFICATION

Set up a geofence, so any time a trailer enters the lot, it uploads data to a cloud-based server and generates a notification to the maintenance manager of any failures.

• THE SYSTEM IS HIGHLY VERSATILE

Simply integrating with the trailer via one of three Grote® nosebox options working with both LED and incandescent lights for all trailer types.

• MAXIMIZE SECURITY AND UPTIME

• MINIMIZE MAINTENANCE COST AND CSA EXPOSURE

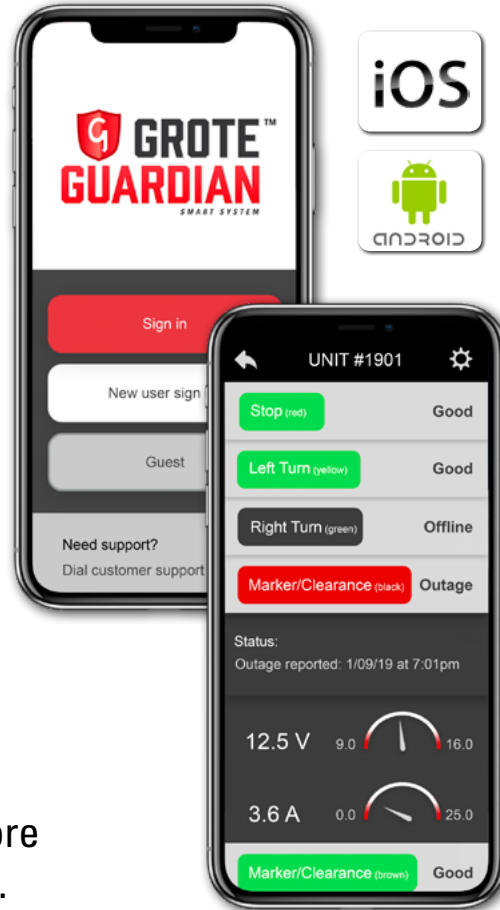

Visit Grote.com/Guardian to learn more and watch Grote Guardian® in action.

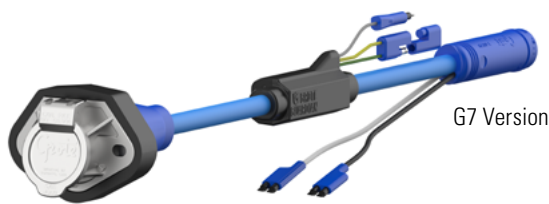

G7 Version



Geofence Gateway

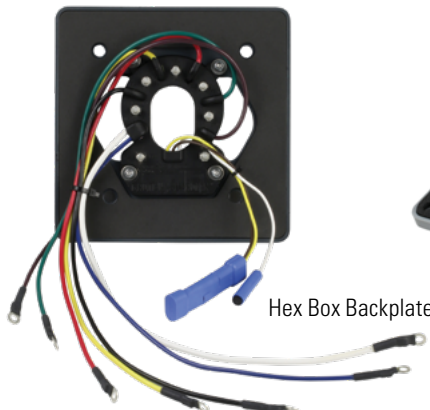

Hex Box Backplate

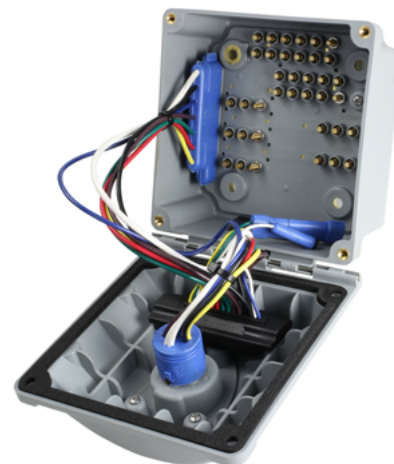

Ultra Nose Box Gen 3

VMRS Code: 036-009-000

Ultra-Blue-Seal®
UBS

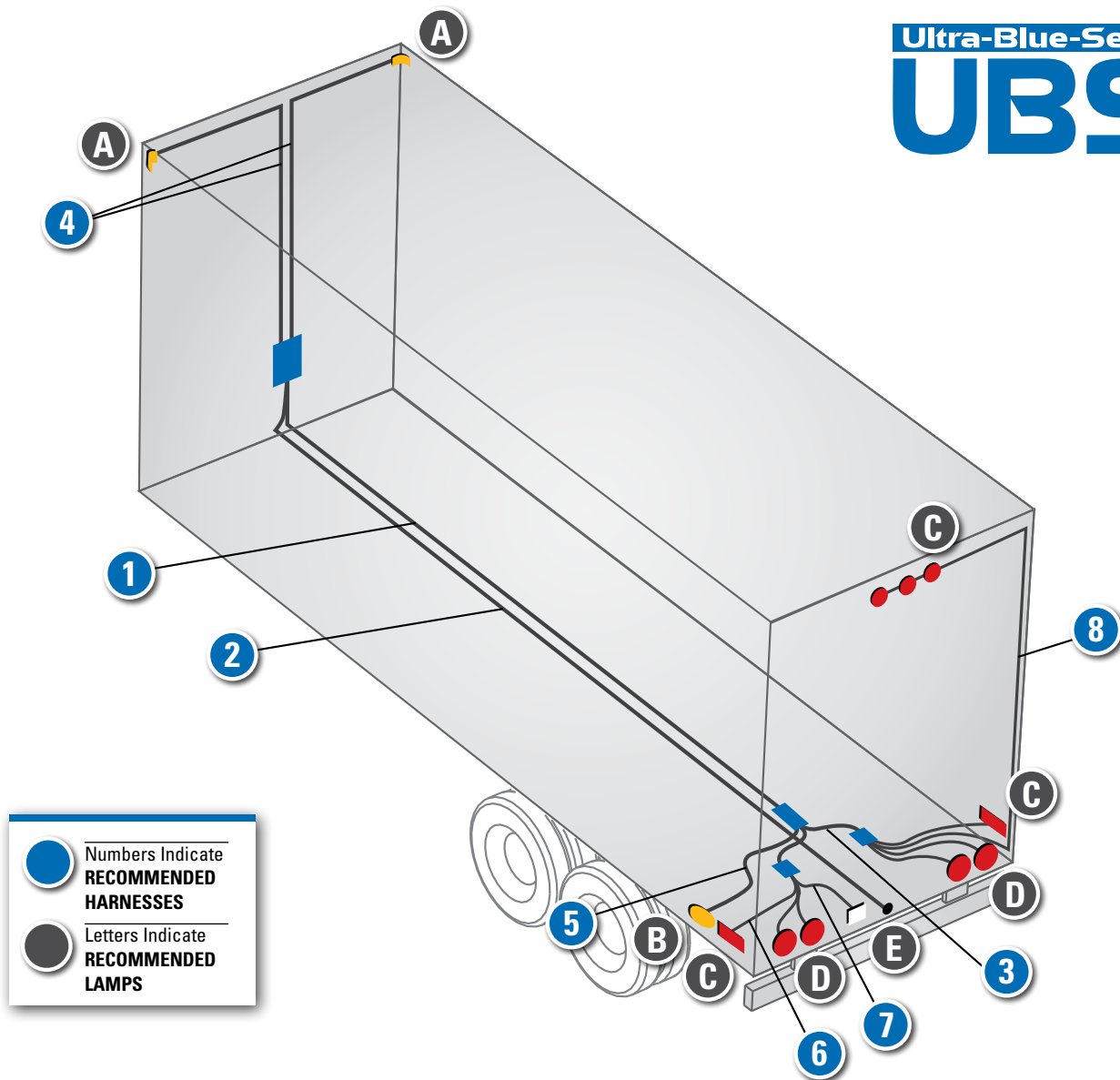

RECOMMENDED LAMPS

A FRONT MARKERS

SuperNova® 3" Thin-Line LED Clearance/Marker Lamp	Page 47
SuperNova® Sealed Turtleback® II LED Clearance/Marker Lamp	Page 55
MicroNova® DOT LED Clearance/Marker Lamp	Page 35
MicroNova® LED Clearance/Marker Lamp	Page 36

B ABS

MicroNova® DOT LED Clearance/Marker Lamp	Page 35
MicroNova® LED Clearance/Marker Lamp	Page 36

C REAR SIDE, CLEARANCE MARKERS & REAR I.D.

SuperNova® 3" Thin-Line LED Clearance/Marker Lamp	Page 47
SuperNova® Sealed Turtleback® II LED Clearance/Marker Lamp	Page 55
MicroNova® DOT LED Clearance/Marker Lamp	Page 35
MicroNova® LED Clearance/Marker Lamp	Page 36

D STOP/TAIL/TURN

SuperNova® 4" LED Stop/ Tail/ Turn Lamp	Page 75
SuperNova® 4" NexGen LED Stop/Tail/Turn	Page 77

E LICENSE

MicroNova® Multi-Volt LED License Lamp	Page 119
MicroNova® Multi-Volt DOT LED License Lamp	Page 119

28' VAN TRAILER ULTRA-BLUE-SEAL® HARNESS SYSTEM

1 MAIN HARNESS

Part #	Front Connection	ABS Drop	Wire Gauge	Length	VMRS Code
01-6670-L5	#10 Ring Terminal	60"	1-8, 2-10, 4-12	420"	034-004-023

2 PINTLE MAIN

Part #	Forward Connection	Rear Connection	Wire Gauge	Length	VMRS Code
01-6660-K3	#10 Ring Terminal	Push-On	1-8, 2-10, 4-12	420"	034-004-023
66601	#10 Ring Terminal	#10 Ring Terminal	1-8, 2-10, 4-12	420"	034-004-023

3 REAR SILL

Part #	Lamp Plug	Curb Side	Road Side	ABS Drop	VMRS Code
01-6758-86	Straight Male Pin	60"	50"	53"	034-004-023
01-6758-87	Straight Male Pin	89"	16"	18"	034-004-023

4 FRONT MARKER HARNESS

Part#	Lamp Connection	Power Connection	Length	Side	VMRS Code
66222	.180 Slim-Line Female	.180 Slim-Line Male	96"	Road	034-004-023
05-2018-93	.180 Slim-Line Female	.180 Slim-Line Male	144"	Curb	034-004-023
01-6620-C8	.180 Slim-Line Female	#10 ring terminal	96"	Road	034-004-023
01-6620-C9	.180 Slim-Line Female	#10 Ring Terminal	144"	Curb	034-004-023

5 ABS FAULT LAMP HARNESS

Part#	Lamp Connection	Power Connection	Length	VMRS Code
66203	.180 Slim-Line Female	.180 Slim Line Male	72"	034-004-023

6 REAR MARKER HARNESS

Part#	Lamp Connection	Power Connection	Length	VMRS Code
01-6707-A9	Turtleback® II	.180 Slim-Line Male	24"	034-004-042
01-6693-74	Thinline LED	.180 Slim-Line Male	24"	034-004-042
05-2018-47	.180 Slim-Line Female	.180 Slim-Line Male	24"	034-004-023

7 LICENSE LAMP HARNESS

Part#	Lamp Connection	Power Connection	Length	VMRS Code
66221	.180 Slim-Line Female	.180 Slim-Line Male	60"	034-004-023

8 REAR I.D. HARNESS

Part#	Lamp Connection	Power Connection	Length	VMRS Code
01-6707-C3	Turtleback® II	.180 Slim-Line Male	120" w/12" On Center Spacing	034-004-023
66402	Thinline LED	.180 Slim-Line Male	120" w/12" On Center Spacing	034-004-023
01-6621-A9	.180 Slim-Line Female	.180 Slim-Line Male	120" w/12" On Center Spacing	034-004-023

Lamp connection descriptions and information begins on page 255

Ultra-Blue-Seal®
UBS

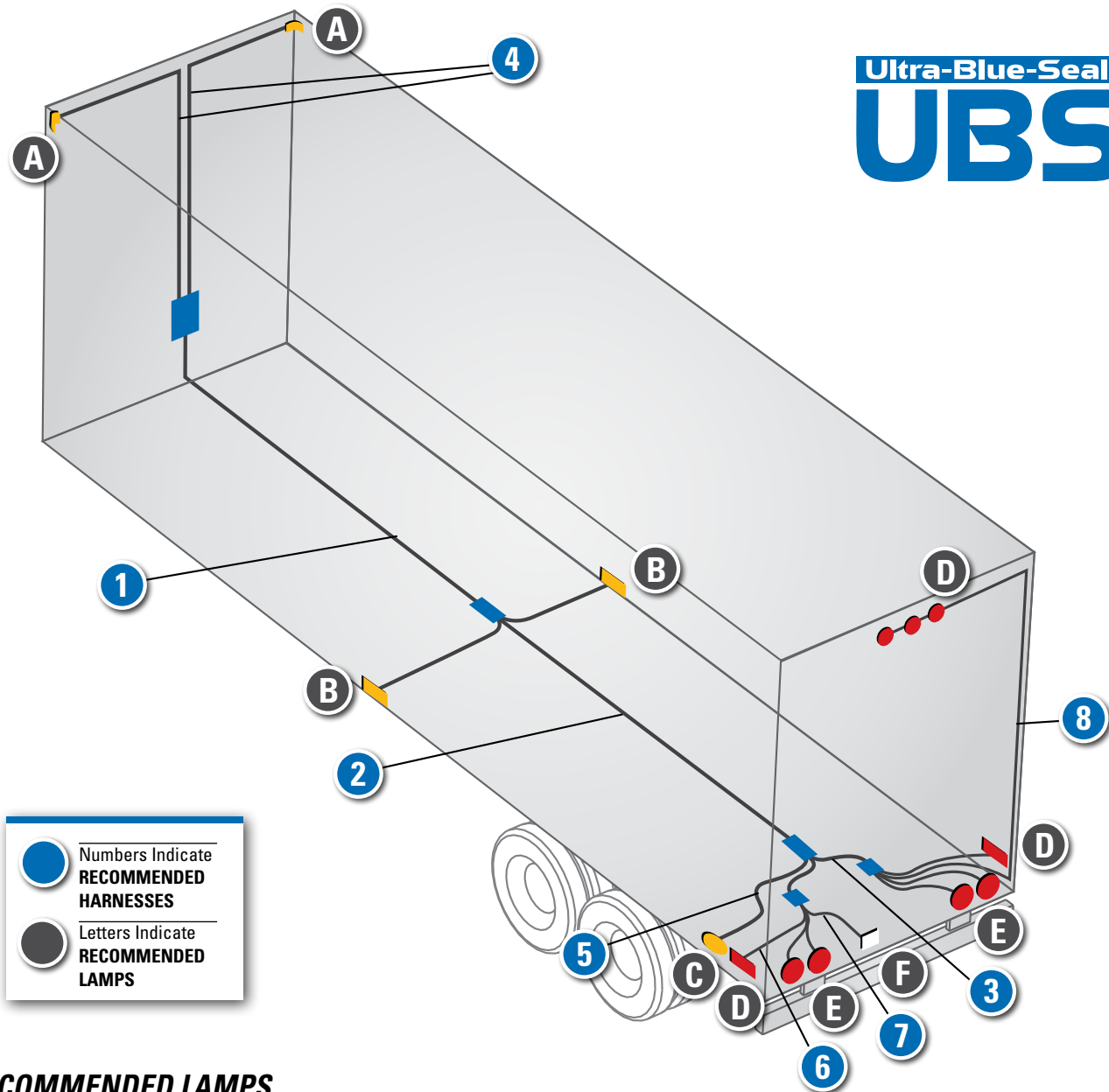

RECOMMENDED LAMPS

A FRONT MARKERS

SuperNova® 3" Thin-Line LED Clearance/Marker Lamp	Page 47
SuperNova® Sealed Turtleback® II LED Clearance/Marker Lamp	Page 55
MicroNova® DOT LED Clearance/Marker Lamp	Page 35
MicroNova® LED Clearance/Marker Lamp	Page 36

B MID-TURN

SuperNova® Oval LED Side Turn/Marker Lamp	Page 86
---	---------

C ABS

MicroNova® DOT LED Clearance/Marker Lamp	Page 35
MicroNova® LED Clearance/Marker Lamp	Page 36

D REAR SIDE, CLEARANCE MARKERS & REAR I.D.

SuperNova® 3" Thin-Line LED Clearance/Marker Lamp	Page 47
SuperNova® Sealed Turtleback® II LED Clearance/Marker Lamp	Page 55
MicroNova® DOT LED Clearance/Marker Lamp	Page 35
MicroNova® LED Clearance/Marker Lamp	Page 36

E STOP/TAIL/TURN

SuperNova® 4" LED Stop/ Tail/ Turn Lamp	Page 75
SuperNova® 4" NexGen LED Stop/Tail/Turn	Page 77

F LICENSE

MicroNova® Multi-Volt LED License Lamp	Page 119
MicroNova® Multi-Volt DOT LED License Lamp	Page 119

53' VAN TRAILER ULTRA-BLUE-SEAL® HARNESS SYSTEM**1 FORWARD MAIN**

Part #	Front Connection	Curb Side	Road Side	Wire Gauge	Length	VMRS Code
01-6661-A2	Push-On	56"	56"	1-10, 6-12	375"	034-004-023
01-6660-M6	Push-On	108"	15"	1-10, 6-12	375"	034-004-023
01-6605-W3	#10 Ring Terminal	108"	15"	1-10, 6-12	375"	034-004-023
01-6606-X3	#10 Ring Terminal	56"	56"	1-10, 6-12	375"	034-004-023

2 INTERMEDIATE MAIN

Part #	Length	ABS Drop	Wire Gauge	VMRS Code
01-6605-W7	342"	132"	1-10, 6-12	034-004-023
01-6605-X4	288"	180"	1-10, 6-12	034-004-023

3 REAR SILL

Part #	Lamp Plug	Curb Side	Road Side	ABS Drop	Wire Gauge	VMRS Code
01-6758-86	Straight Male Pin	60"	50"	53"	1-12, 4-14	034-004-023
01-6758-87	Straight Male Pin	89"	16"	18"	1-12, 4-14	034-004-023

4 FRONT MARKER HARNESS

Part#	Lamp Connection	Power Connection	Length	Side	VMRS Code
66222	.180 Slim-Line Female	.180 Slim-Line Male	96"	Road	034-004-023
05-2018-93	.180 Slim-Line Female	.180 Slim-Line Male	144"	Curb	034-004-023
01-6620-C8	.180 Slim-Line Female	#10 ring terminal	96"	Road	034-004-023
01-6620-C9	.180 Slim-Line Female	#10 Ring Terminal	144"	Curb	034-004-023

5 ABS FAULT LAMP HARNESS

Part#	Lamp Connection	Power Connection	Length	VMRS Code
66203	.180 Slim-Line Female	.180 Slim-Line Male	72"	034-004-023

6 REAR MARKER HARNESS

Part#	Lamp Connection	Power Connection	Length	VMRS Code
01-6707-A9	Turtleback® II	.180 Slim-Line Male	24"	034-004-042
01-6693-74	Thinline LED	.180 Slim-Line Male	24"	034-004-042
05-2018-47	.180 Slim-Line Female	.180 Slim-Line Male	24"	034-004-023

7 LICENSE LAMP HARNESS

Part#	Lamp Connection	Power Connection	Length	VMRS Code
66221	.180 Slim-Line Female	.180 Slim-Line Male	60"	034-004-023

8 REAR I.D. HARNESS

Part#	Lamp Connection	Power Connection	Length	VMRS Code
01-6707-C3	Turtleback® II	.180 Slim-Line Male	120" w/12" On Center Spacing	034-004-023
66402	Thinline LED	.180 Slim-Line Male	120" w/12" On Center Spacing	034-004-023
01-6621-A9	.180 Slim-Line Female	.180 Slim-Line Male	120" w/12" On Center Spacing	034-004-023

Lamp connection descriptions and information begins on page 255

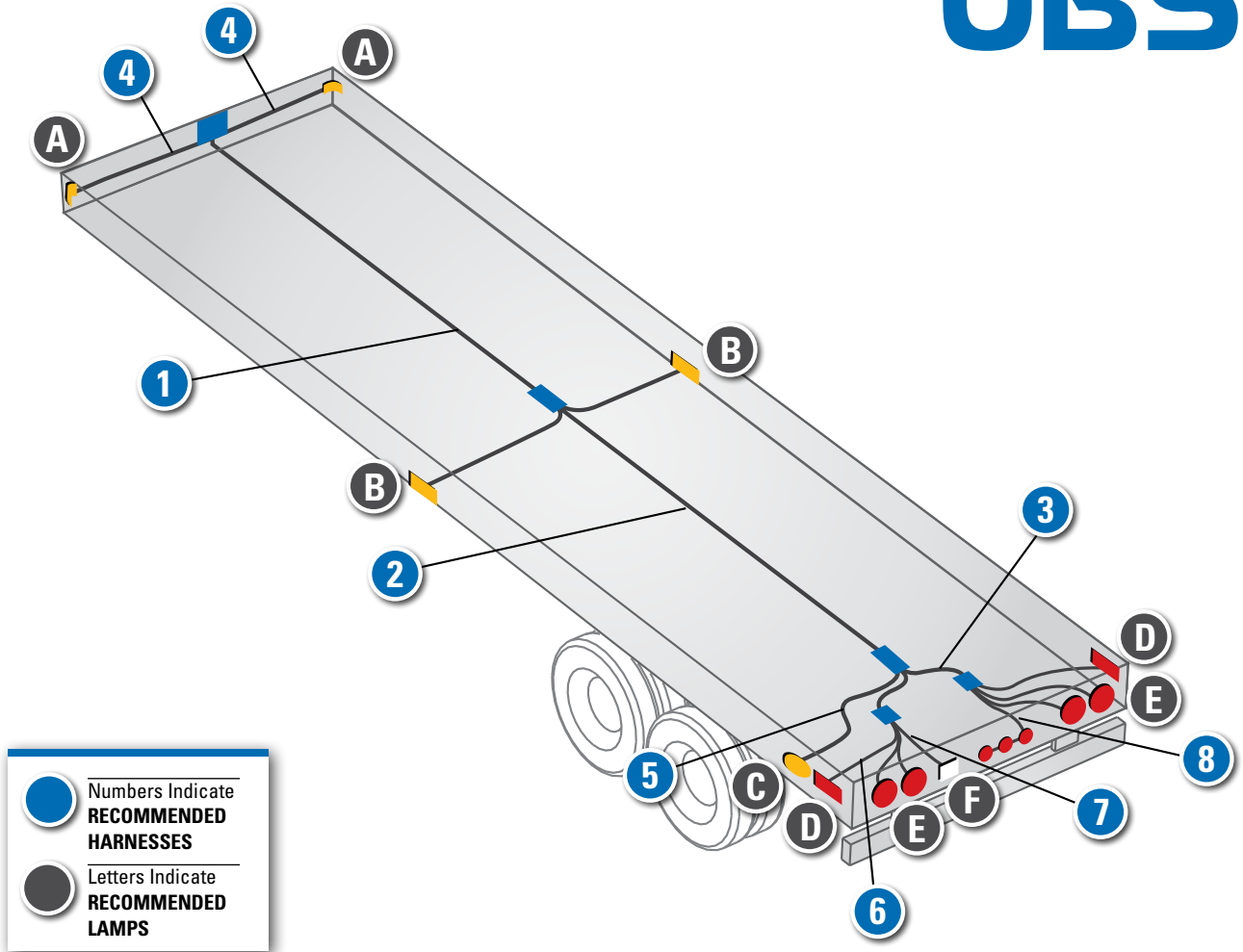

Numbers Indicate RECOMMENDED HARNESSES

Letters Indicate RECOMMENDED LAMPS

RECOMMENDED LAMPS

A FRONT MARKERS

SuperNova® 3" Thin-Line LED Clearance/Marker Lamp	Page 47
SuperNova® Sealed Turtleback® II LED Clearance/Marker Lamp	Page 55
MicroNova® DOT LED Clearance/Marker Lamp	Page 35
MicroNova® LED Clearance/Marker Lamp	Page 36

B MID-TURN

SuperNova® Oval LED Side Turn/Marker Lamp	Page 86
---	---------

C ABS

MicroNova® DOT LED Clearance/Marker Lamp	Page 35
MicroNova® LED Clearance/Marker Lamp	Page 36

D REAR SIDE, CLEARANCE MARKERS & REAR I.D.

SuperNova® 3" Thin-Line LED Clearance/Marker Lamp	Page 47
SuperNova® Sealed Turtleback® II LED Clearance/Marker Lamp	Page 55
MicroNova® DOT LED Clearance/Marker Lamp	Page 35
MicroNova® LED Clearance/Marker Lamp	Page 36

E STOP/TAIL/TURN

SuperNova® 4" LED Stop/ Tail/ Turn Lamp	Page 75
SuperNova® 4" NexGen LED Stop/Tail/Turn	Page 77

F LICENSE

MicroNova® Multi-Volt LED License Lamp	Page 119
MicroNova® Multi-Volt DOT LED License Lamp	Page 119

53' FLATBED ULTRA-BLUE-SEAL® HARNESS SYSTEM

1 MAIN HARNESS

Part #	Front Connection	Curb Side	Road Side	Wire Gauge	Length	VMRS Code
01-6661-A2	Push-On	56"	56"	1-10, 6-12	375"	034-004-023
01-6660-M6	Push-On	108"	15"	1-10, 6-12	375"	034-004-023
01-6605-W3	#10 Ring Terminal	108"	15"	1-10, 6-12	375"	034-004-023
01-6606-X3	#10 Ring Terminal	56"	56"	1-10, 6-12	375"	034-004-023

2 INTERMEDIATE MAIN

Part #	Length	ABS Drop	Wire Gauge	VMRS Code
01-6605-W7	342"	132"	1-10, 6-12	034-004-023
01-6605-X4	288"	180"	1-10, 6-12	034-004-023

3 REAR SILL

Part #	Lamp Plug	Curb Side	Road Side	ABS Drop	VMRS Code
01-6758-86	Straight Male Pin	60"	50"	53"	034-004-023
01-6758-87	Straight Male Pin	89"	16"	18"	034-004-023

4 FRONT MARKER HARNESS

Part#	Lamp Connection	Power Connection	Length	Side	VMRS Code
01-6620-E9	.180 Slim-Line Female	.180 Slim-Line Male	48"	Road	034-004-023
66222	.180 Slim-Line Female	.180 Slim-Line Male	96"	Curb	034-004-023
01-6620-F1	.180 Slim-Line Female	.180 Slim-Line Male	48"	Road	034-004-023
01-6620-C8	.180 Slim-Line Female	#10 Ring terminal	96"	Road	034-004-023
01-6620-F2	.180 Slim-Line Female Flo-Thru	.180 Slim-Line Male	48"	Road	034-004-023
01-6621-C1	.180 Slim-Line Female Flo-Thru	.180 Slim-Line Male	96"	Curb	034-004-023
01-6620-F3	.180 Slim-Line Female Flo-Thru	#10 Ring Terminal	48"	Road	034-004-023
01-6621-C3	.180 Slim-Line Female Flo-Thru	#10 Ring Terminal	96"	Curb	034-004-023

5 ABS FAULT LAMP HARNESS

Part#	Lamp Connection	Power Connection	Length	VMRS Code
66203	.180 Slim-Line Female	.180 Slim-Line Male	72"	034-004-023

6 REAR MARKER HARNESS

Part#	Lamp Connection	Power Connection	Length	VMRS Code
01-6707-A9	Turtleback® II	.180 Slim-Line Male	24"	034-004-042
01-6693-74	Thinline LED	.180 Slim-Line Male	24"	034-004-042
05-2018-47	.180 Slim-Line Female	.180 Slim-Line Male	24"	034-004-023

7 LICENSE LAMP HARNESS

Part#	Lamp Connection	Power Connection	Length	VMRS Code
66221	.180 Slim-Line Female	.180 Slim-Line Male	60"	034-004-023

8 REAR I.D. HARNESS

Part#	Lamp Connection	Power Connection	Length	VMRS Code
01-6707-C2	Turtleback® II	.180 Slim-Line Male	36" w/12" On Center Spacing	034-004-023
66403	Thinline LED	.180 Slim-Line Male	36" w/12" On Center Spacing	034-004-023
01-6621-C7	.180 Slim-Line Female	.180 Slim-Line Male	36" w/9" On Center Spacing	034-004-023

Lamp connection descriptions and information begins on page 255

GROTE® ULTRALINK POWER CORDS: SUPERIOR POWER DELIVERY

Grote's UltraLink Cords provide maximum reliability in the harshest environments. UltraLink Power Cords feature a crush-resistant plug and deliver improved performance, longer wear, and superior conductivity at a competitive price.

PLUG DESIGN

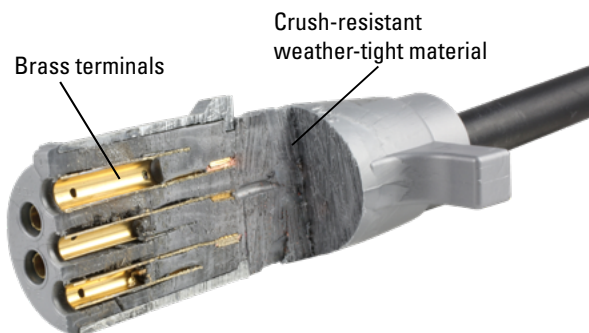

CABLE-TO-PLUG SEAL

Cable jacket is molded into the plug, sealing it from the elements and eliminating the need for an additional strain relief.

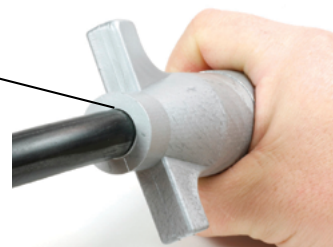

BRASS TERMINALS

Two rugged spring clips on each terminal prevent excessive opening of the terminals and greatly reduce intermittent connections.

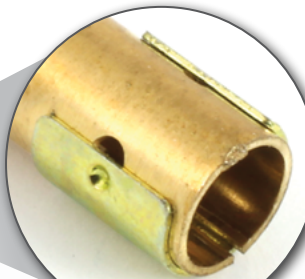
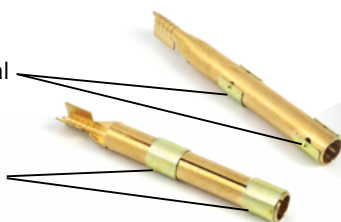

ULTRALINK ABS POWER CORDS

UltraLink power cords exceed minimum legal lamp power delivery requirements for single or double trailer configurations

- Zinc die-cast plugs are filled with elastomeric material that resists crushing & acts as potting to seal solid brass terminals from moisture
- Provides excellent recoil memory, chemical, and abrasion resistance
- Adhesive bonds cable to plug, eliminating need for supporting spring and preventing moisture from entering the back of the plug
- Solid brass terminals are corrosion resistant, and provide superior current capacity with minimal voltage drop
- Advanced polymer jacketing material provides complete sealing and abrasion protection between -55°F and 190°F (premium versions)

COILED:

87100	1/8, 2/10, 4/12, 12', w/12" Leads, Coiled
87103	1/8, 2/10, 4/12, 12', w/12" Leads, Coiled, Premium
87101	1/8, 2/10, 4/12, 15', w/12" Leads, Coiled
87104	1/8, 2/10, 4/12, 15', w/12" Leads, Coiled, Premium
87105	1/8, 2/10, 4/12, 20', w/36" and 12" Leads, Coiled, Premium
87170	1/8, 2/10, 4/12, 15', w/48" and 12" Leads, Coiled

STRAIGHT:

87190	1/8, 2/10, 4/12, 7', Straight
87191	1/8, 2/10, 4/12, 8', Straight
87192	1/8, 2/10, 4/12, 9', Straight
87193	1/8, 2/10, 4/12, 10', Straight
87171	1/8, 2/10, 4/12, 12', Straight
87172	1/8, 2/10, 4/12, 15', Straight
87173	1/8, 2/10, 4/12, 20', Straight

Material: Polyurethane (Premium), EVA (Standard)

Regulations / Standards: SAE J560b™, J2222™, J2394™

Finish: Green

VMRS Code: 034-003-037



ULTRALINK POWER CORDS (NON-ABS)

UltraLink power cords exceed minimum legal lamp power delivery requirements for single or double trailer configurations

- Zinc die-cast plugs are filled with elastomeric material that resists crushing & acts as potting to seal solid brass terminals from moisture
- Adhesive bonds cable to plug, eliminating need for supporting spring and preventing moisture from entering the back of the plug
- Solid brass terminals are corrosion resistant, and provide superior current capacity with minimal voltage drop

COILED:

87110	1/12, 6/14, 12', w/12" Leads
87020	1/10, 6/12, 12', w/12" Leads, HD
87111	1/12, 6/14, 15', w/12" Leads
87023	1/10, 6/12, 15', w/12" Leads, HD
87181	1/10, 6/12, 15', w/48" and 12" Leads, HD
87112	1/12, 6/14, 15', w/72" and 12" Leads
87180	1/10, 6/12, 15', w/72" and 12" Leads, HD

STRAIGHT:

87182	1/10, 6/12, 15'
--------------	-----------------

Material: EVA (Standard)

Regulations / Standards: SAE J560™, J2222™

Finish: Black

VMRS Code: 034-003-037



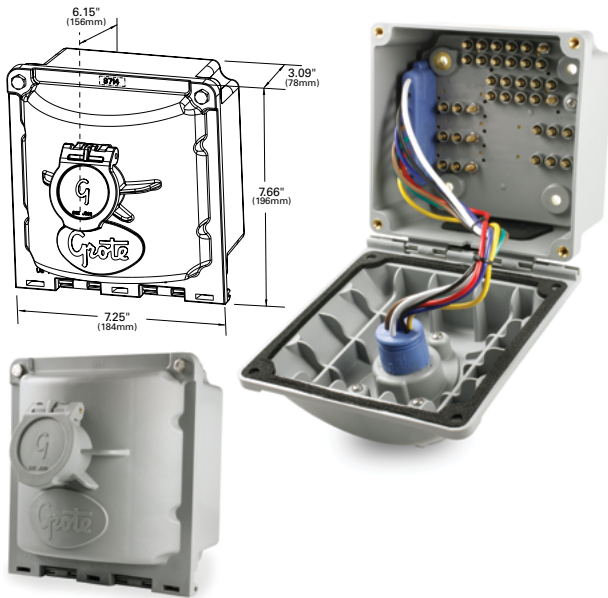

ULTRA NOSE BOX

Replaceable 7-pin insert for easy maintenance • 39-pin connections eliminates overcrowding of wires • Hinged door keeps elements out, while providing easy access • Insert-molded pins helps prevent accidental disconnects

- 87141** Gray, Solid Pin
87151 Gray, Split Pin

Material: Nylon

Regulations / Standards: SAE J560™

Finish: Gray

Accessory: 7-pin insert: 97900 (solid pin), 97800 (split pin)

Replacement Door, Largo, Solid Pin: 97831

Rubber Grommet: 97810

Pigtail: 01-6623-P9

20A Circuit Breaker: 01-6624-W4

VMRS Code: 034-003-034

ULTRA-PIN RECEPTACLE TWO-HOLE MOUNT

No-rust, die-cast zinc • Heavy bosses for extra rigidity • Barrel slanted to drain moisture • Mounting holes slotted for universal fit • Floating pins for easy alignment and solid mating • Two male terminals for grounding • Brass pins • 87270 includes 99510 retrofit kit • 99510 consists of 14 terminals and 9 boots

- 87250** Receptacle Only, Split Pin
87860 Receptacle Only, Solid Pin
87270 Receptacle w/ Terminal Kit, Split Pin

RETROFIT KIT

- 99510** Plug-In Terminal Kit
99680 Door Replacement Kit

Material: Die-cast Zinc

Regulations / Standards: SAE J560™

VMRS Code: 034-003-034 - 87250, 57260, 87270, 99680
 034-004-023 - 99510

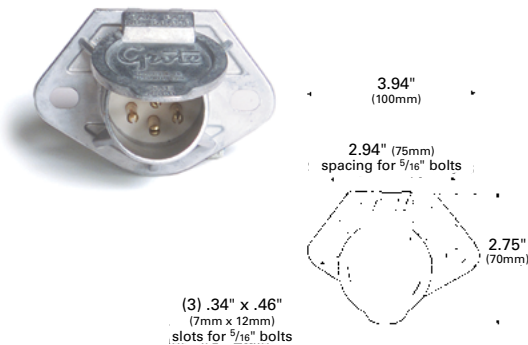

ULTRA-PIN RECEPTACLE THREE-HOLE MOUNT

No-rust, die-cast zinc • Heavy bosses for extra rigidity • Barrel slanted to drain moisture • Mounting holes slotted for universal fit • Floating pins for easy alignment and solid mating • Two male terminals for grounding • Brass pins • 87240 includes 99510 retrofit kit • 99510 consists of 14 terminals and 9 boots

- 87240** Receptacle w/ Terminal Kit, Split Pin
87220 Receptacle Only, Split Pin

RETROFIT KIT

- 99510** Plug-In Terminal Kit
99680 Door Replacement Kit

Material: Die-cast Zinc

Regulations / Standards: SAE J560™

VMRS Code: 034-003-034 - 87240, 87220, 99680
 034-004-023 - 99510
 034-004-075 - 99601

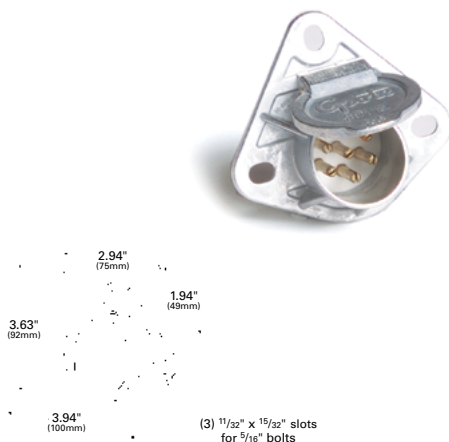

ULTRA-PIN RECEPTACLE FOUR-HOLE MOUNT NOSE BOX

Extra-heavy bosses • Slanted barrel for drainage • Floating pins for easy alignment and solid mating connection • High-impact retainer plate
 • Brass pins • Die-cast aluminum housing resists rust

- 87590** Solid Pin
- 87830** Split Pin

Material: Die-cast Aluminum
VMRS Code: 034-003-034

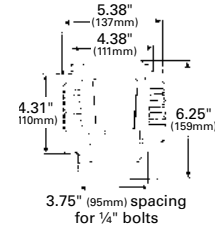

RECEPTACLE MOUNTING BOX

Mounting for 87250, 87860, 87270, 87220, 87850, 87240

- 43684** Receptacle Box
- 99680** Door Replacement Kit - Used on 87250, 87860, 87270, 87240 and 87220. Kit contains die-cast zinc door, brass hinge pin and spring

Material: Cast Aluminum
VMRS Code: 034-003-034

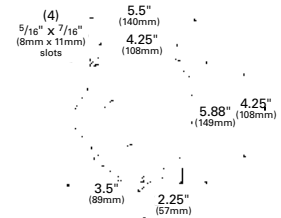

RETROFIT PLUG-IN TERMINAL KIT

- 99510** Plug-In Terminal Kit - Plugs into 87220, 87850, 87250, 87860, 87590 and 87830 receptacles • Kit contains 9 boots and 14 terminals • 5 terminals for larger gauge wire
- 99680** Door Replacement Kit - Used on 87250, 87860, 87270, 87240 and 87220. Kit contains die-cast zinc door, brass hinge pin and spring

VMRS Code: 034-004-023 - 99510
 034-003-034 - 99680
 034-004-075 - 99601



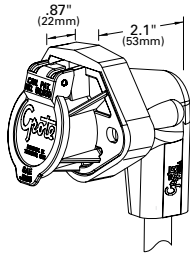

87212



87214

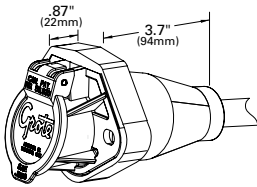

ULTRA-SEAL G7

Ultra-Seal G7 is the standard for low-profile, water-resistant harness connection

- Spacer made of thicker and harder durometer PVC that resists deforming under mounting pressure
- Flush-mount design allows water to be directed away from the wire exit hole in the trailer
- Two alignment pins aid in installation, allowing for easier terminal connections
- Plug design seals the back of the receptacle
- Receptacle is recessed into the gasket for sealing
- Receptacle is non-rust, die-cast zinc with solid brass pins

87214 Straight Plug & Receptacle With 7-Way Female

Length: 24"/610mm

Gauge: 1/10, 6/12

87215 Straight Plug & Receptacle With 7-Way Male

Length: 24"/610mm

Gauge: 1/8, 2/10, 4/12

87210 90° Plug & Receptacle With 7-Way Female And Drops For Marker Lamps (Grounded And Black)

Length: 24"/610mm

Gauge: 1/10, 6/12

87211 90° Plug & Receptacle With 7 Standard Females And Drops For Marker Lamps (Grounded And Black)

Length: 24"/610mm

Gauge: 1/10, 6/12

87212 90° Plug & Receptacle Blunt Cut With Drops For Marker Lamps (Grounded And Black)

Length: 24"/610mm

Gauge: 1/10, 6/12

VMRS Code: 034-002-036

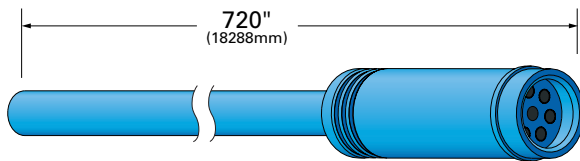

ULTRA-BLUE-SEAL® MAIN HARNESS

Extends from front of nose box or receptacle and provides sealed plug-in connection to real sill harness

1-8 GAUGE, 2-10 GAUGE, 4-12 GAUGE:

66071 60' Long

VMRS Code: 034-004-023

ULTRA-BLUE-SEAL® MAIN HARNESS ABS ADAPTER

Junction between main harness and real sill harness

- Provides sealed plug-in connection and a drop-out extension for ABS
- Ground return
- ABS fault lamp connection

ABS FAULT LIGHT:

66705 12" Long

VMRS Code: 034-004-023

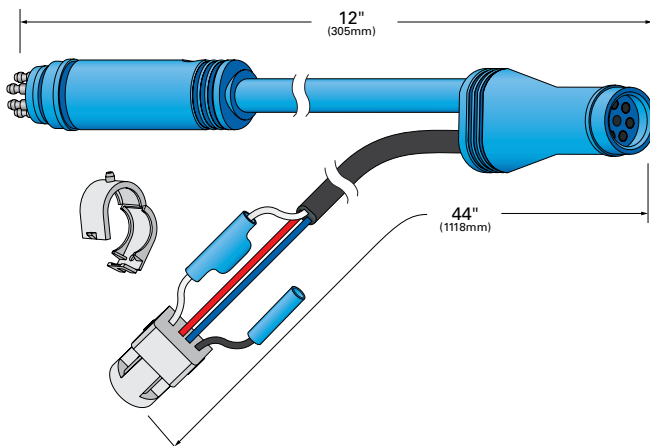

ULTRA-BLUE-SEAL® 7-CONDUCTOR RECEPTACLE MAIN HARNESS

Ultra-Pin receptacle is overmolded • Two-hole mount, solid pin (87860)

- 01-6608-E9 Main Harness with Drop (female 7-way)
- 01-6608-F9 Main Harness (male 7-way)

VMRS Code: 034-004-023

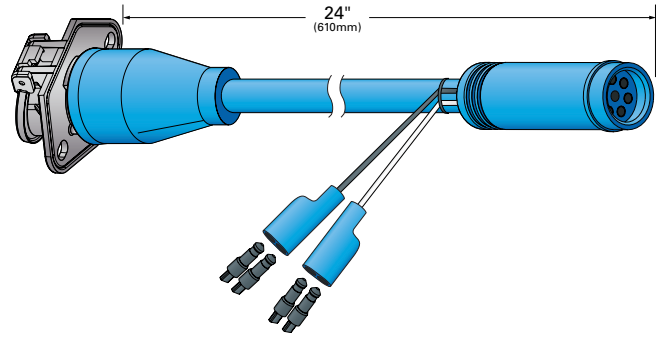

ULTRA-BLUE-SEAL® HARNESS REAR SILL OPTION

All connections weather-sealed by simple, foolproof UBS plugs • Entire harness double-jacketed for extra resistance to road-splash and abrasion
 • Redundant frame ground with ring terminal

FOR FEMALE PIN LAMPS:

- 67570 56" Long, Ground Return, Blue Drop
- 67571 56" Long, Ground Return, ABS Connection

FOR MALE PIN LAMPS:

- 67581 56" Long, Ground Return, Blue Drop
- 67580 56" Long, Ground Return, ABS Connection

VMRS Code: 034-004-023

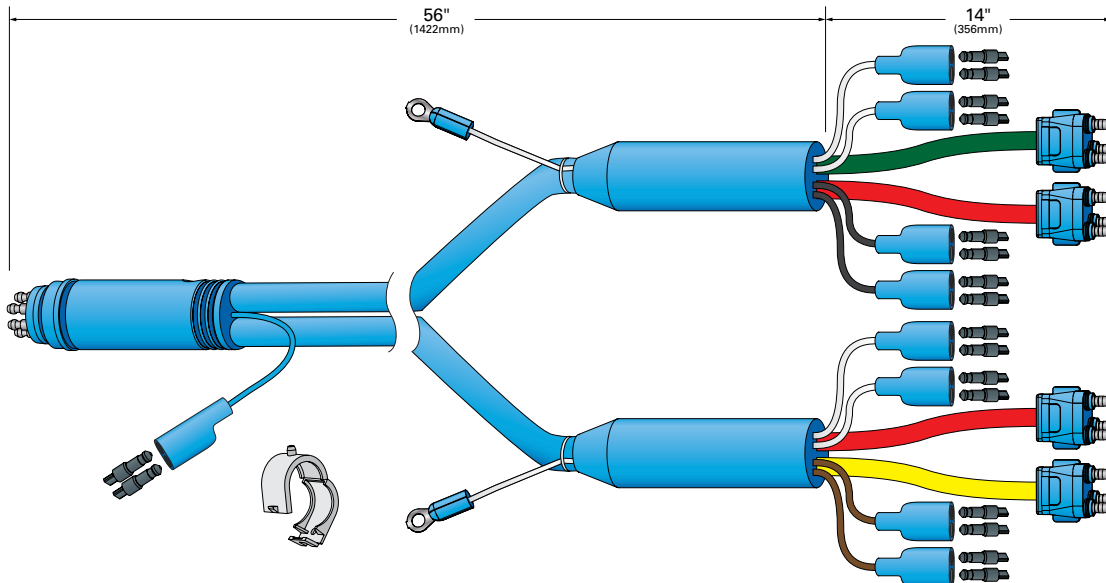

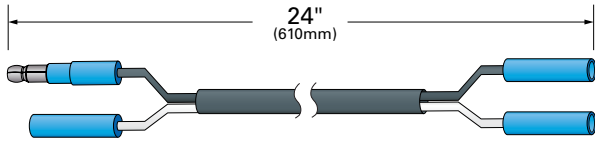

ULTRA-BLUE-SEAL® GROUND RETURN TRACKING HARNESS

For use with elbow-style rear sill

STANDARD MALE/STANDARD FEMALE TO 2 SLIM-LINE UNDERLAMP FEMALES:

- 66223 2' Long
66224 3' Long

VMRS Code: 034-004-023

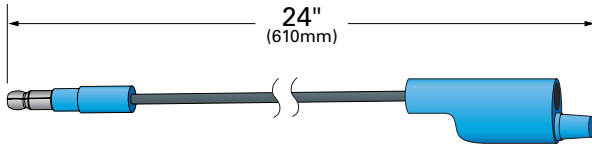

CUT-TO-FIT® WIRE HARNESS SYSTEMS

This Cut-To-Fit® Wire Harness System adapts to the standard Grote® Ultra-Blue-Seal® rear sill and main harness • Part number 67271 (24" standard male to Cut-To-Fit® Slim-Line jumper) plugs into rear sill, making a corrosion-proof connection • Cut-To-Fit® jumpers can then be plugged directly into the double Slim-Line plugs • Cut-To-Fit® wire harness mates with the Grote® 7-pin receptacle (nose box) with the use of either the 67260 adapter or the 67250 • All wires 12-gauge

- 67271 Rear Sill Adapter
67260 Nose Box Adapter
67250 Double Nose Box Adapter

VMRS Code: 034-004-023

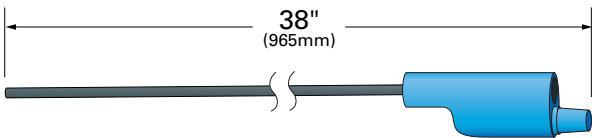

SLIM-LINE UNDER-LAMP FEMALES (CUT-TO-FIT®)

Abrasion-resistant double-jacketed wire lengths with molded-on Slim-Line under-lamp double females includes sealing boot for crimp-on bullet connectors • Blunt-cut, Cut-To-Fit® wires are black

- 67301 14-Gauge, 3' 2" (38")

VMRS Code: 034-004-023

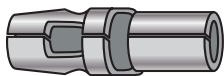

99500-3

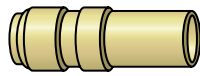

99501-3

CRIMP-ON .180 BULLET TERMINALS

- 99500-3 Field Service Terminal for 14-Gauge Wire
99501-3 Field Service Terminal for 12-Gauge Wire

VMRS Code: 034-004-023

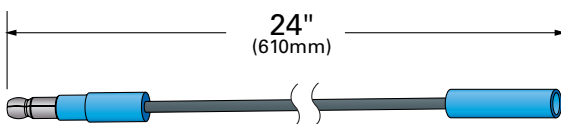

STANDARD MALE TO SLIM-LINE UNDER-LAMP FEMALE

Rear tracking lamp jumper

- 66170 2' (24")

VMRS Code: 034-004-023

STANDARD MALE TO STANDARD FEMALE

66100 - License lamp jumper (as shown) • 66101 - Intermediate turn signal jumper, use with 66200 from front receptacle

- 66100** 4' 4" (50")
- 66101** 28' 3" (339")

VMRS Code: 034-004-023

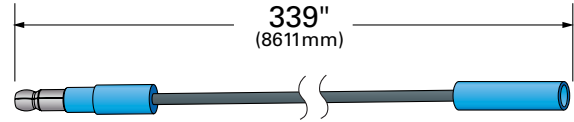

SLIM-LINE UNDER-LAMP MALE TO STANDARD FEMALE

Jumper to access auxiliary drop-out on rear sill harness

- 66110** 5' (60")

VMRS Code: 034-004-042

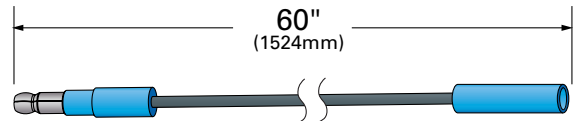

SLIM-LINE UNDER-LAMP MALE TO SLIM-LINE UNDER-LAMP FEMALE

- 66162** Intermediate Side Marker Crossover Jumper, 8' 9" (105")

VMRS Code: 034-004-023

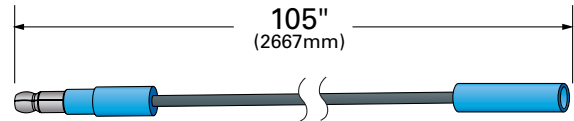

SLIM-LINE UNDER-LAMP MALE TO SLIM-LINE UNDER-LAMP FEMALE

- 66160** Multiple ID lamp jumper, 1' (12")
- 66124** Front marker and rear marker lamp jumper, 2' 6" (30")
- 66161** Front lower side marker from front receptacle.
Use with 66190, 4' 7" (55")
- 66125** Marker lamp jumper, 7' (84")
- 66123** Marker lamp jumper, 10' 9" (129")
- 66163** Front upper clearance / marker from front receptacle.
Use with 66190, 12' 8" (152")
- 66122** Marker lamp jumper 16' (192")
- 66113** Clearance lamp jumper 26' 11" (323")

VMRS Code: 034-004-023

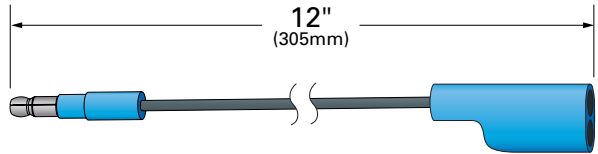

BLUNT-CUT TO DOUBLE SLIM-LINE UNDER-LAMP FEMALE

- 66190** Wire into front receptacle terminals, 8" blunt cut

VMRS Code: 034-004-023

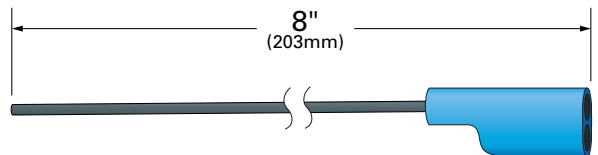

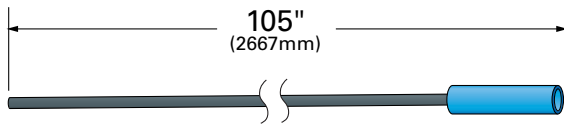
**BLUNT-CUT TO STANDARD FEMALE**

66200 Wire into front receptacle terminals, 8" blunt cut

VMRS Code: 034-004-023

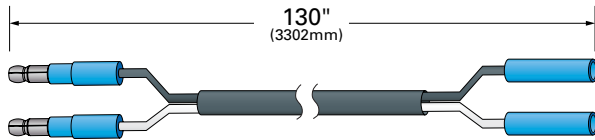
**TWO STANDARD MALES TO TWO SLIM-LINE UNDER-LAMP FEMALES**

66220 - Use the 5306 combination clearance / marker and auxiliary stop / turn signal lamp, use with 66400 when triple-ID / Auxiliary stop is located on upper rail, 10' 10" (130") • Wire is 14 gauge

66220 ID / auxiliary stop jumper

66121 Midturn and marker lamp harness, 30' (360")

VMRS Code: 034-004-023

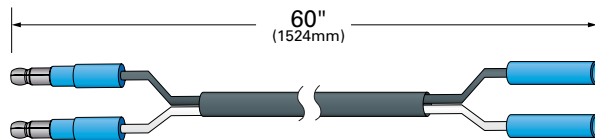
**TWO SLIM-LINE MALES TO TWO SLIM-LINE UNDER-LAMP FEMALES**

66221 Marker lamp or ABS fault lamp, 5' (60")

66222 Jumper, 8' (96")

66164 Jumper, 8' 9" (105")

VMRS Code: 034-004-023

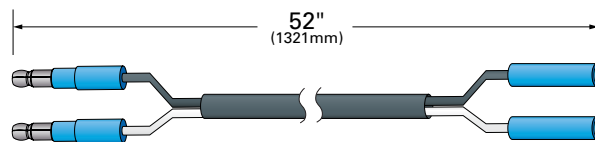
**TWO STANDARD MALES TO TWO STANDARD FEMALES**

66133 Marker lamp jumper, 4' 4" (52")

VMRS Code: 034-004-023

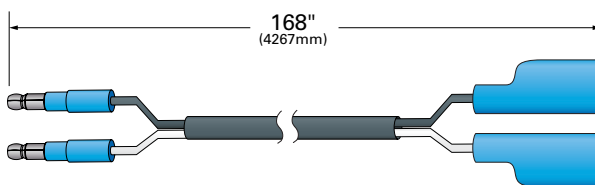
**TWO STANDARD MALES TO TWO DOUBLE FEMALES**

66171 Marker lamp jumper, 14' (168")

66145 Marker lamp jumper, 26' (312")

VMRS Code: 034-004-023

TWO SLIM-LINE MALE TO TWO DOUBLE FEMALES

- 66165** Marker lamp jumper, 1' (12")
- 66155** Marker lamp jumper, 2' 6" (30")
- 66154** Marker lamp jumper, 4' 7" (55")
- 66153** Marker lamp jumper, 7' (84")
- 66152** Marker lamp jumper, 10' 9" (129")
- 66151** Marker lamp jumper, 12' 8" (152")
- 66150** Marker lamp jumper, 16' (192")
- 66135** Marker lamp jumper, 26' 11" (323")

VMRS Code: 034-004-023

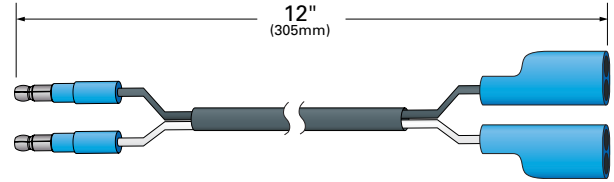

7-CONDUCTOR CABLE:

(SAE J1067™ AND J560™)

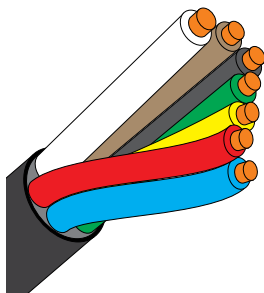

- White Ground (10 ga.)
- Brown Tail and license lamp, and clearance lamps (12 ga.)
- Black Clearance, sidemarker, and identification lamps (12 ga.)
- Yellow Left turn signal lamp (12 ga.)
- Green Right turn signal lamp (12 ga.)
- Red Stop lamps (12 ga.)
- Blue Auxiliary circuit (12 ga.)

HEAVY DUTY 7-CONDUCTOR CABLE SYSTEM:

(SAE J1067™ AND J560™)

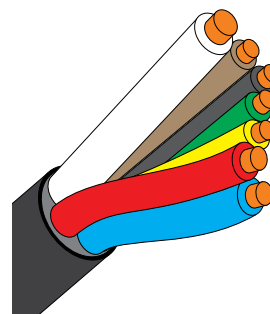

- White Ground (8 ga.)
- Brown Tail and license lamp, and clearance lamps (12 ga.)
- Black Clearance, sidemarker, and identification lamps (12 ga.)
- Yellow Left turn signal lamp (12 ga.)
- Green Right turn signal lamp (12 ga.)
- Red Stop lamps (10 ga.)
- Blue Auxiliary circuit (10 ga.)

WIRE SIZES

No matter what the variety, it's critical to choose the correct wire size for the application. The key information required is the length of wire needed, often referred to as the length of run, and the current load that the conductor is expected to carry in use. Knowing the "length and load" characteristics will take the guesswork out of the choice.

Voltage drop, caused by current draw, is the primary consideration when selecting the proper conductor size. Every conductor has a certain amount of resistance per foot. The longer the distance, the greater the resistance in the circuit. The greater the resistance, the higher the voltage drop caused by the same current. This relationship is defined by Ohm's law (Voltage = Current x Resistance). As distance from the power source increases, there is less voltage available to "push" the current through the

wire. This causes the current to drop. There is also heat buildup as the resistance increases, which also lessens the amount of current flow.

In low-voltage systems, such as vehicles, even a small drop in voltage can have a serious effect on the amount of light a lamp puts out. There's a simple solution. As you get further away from the power source, make the conductor larger. A larger conductor means less resistance.

Using the Wire Size Chart, first find the load in amps on the left edge of the chart. Then find the length of run across the top of the chart. Read down that column until it intersects with the amp load line. The point at which they cross indicates the correct wire size for the job.

Wire Size Chart												
12V (AMP)	24V	48V	Length of Wire (most distant light)									
			10'	20'	30'	40'	50'	60'	70'	80'	90'	100'
Load in Amps	Load in Amps	Load in Amps	Wire Gauge	Wire Gauge	Wire Gauge	Wire Gauge	Wire Gauge	Wire Gauge	Wire Gauge	Wire Gauge	Wire Gauge	Wire Gauge
1	2	4	18	18	18	18	18	18	18	18	18	18
1.5	3	6	18	18	18	18	18	18	18	18	18	18
2	4	8	18	18	18	18	18	18	18	16	16	16
3	6	12	18	18	18	18	18	16	16	16	14	14
4	8	16	18	18	18	16	16	16	14	14	14	12
5	10	20	18	18	18	16	14	14	14	12	12	12
6	12	24	18	18	16	16	14	14	12	12	12	10
7	14	28	18	18	16	14	14	12	12	12	12	10
8	16	32	18	16	16	14	12	12	12	10	10	10
10	20	40	18	16	14	12	12	12	10	10	10	10
11	22	44	18	16	14	12	12	10	10	10	10	8
12	24	48	18	16	14	12	12	10	10	10	8	8
15	30	60	18	14	12	12	10	10	10	8	8	8
18	36	72	16	14	12	10	10	8	8	8	8	8
20	40	80	16	12	12	10	10	8	8	8	8	6

- A) DETERMINE THE TOTAL WIRE LENGTH FROM THE POWER SOURCE TO THE MOST DISTANT POINT IN THE CIRCUIT.
 B) DETERMINE THE TOTAL ELECTRICAL LOAD ON THE CIRCUIT.
 C) FIND THE LOAD ALONG ONE EDGE OF THE CHART DEPENDING ON THE VEHICLE VOLTAGE IN QUESTION, TAKING THE NEXT HIGHER LOAD IF THE INDICATED LOAD FALLS BETWEEN TWO POINTS ON THE CHART.
 D) FIND THE CABLE LENGTH REQUIRED ON THE TOP OF THE CHART, TAKING THE NEXT HIGHER LENGTH (IF EXACT LENGTH IS NOT CITED).
 E) AT THE INTERSECTION OF THE LENGTH AND LOAD COLUMN, READ THE MINIMUM SIZE WIRE REQUIRED FOR THAT PARTICULAR CIRCUIT.

WIRE GAUGES

Conductors may be single strand or a group of strands. Stranded conductors are preferred in heavier gauges because they are more flexible and easier to work with than a comparable single strand conductor.

Comparing stranded cable sizes is simple. Stranded cable is compared using a numerical system. For example, 18/24 indicates that the conductor consists of 18 strands of 24-gauge wire. Similarly 12/12 refers to 12 strands of 12-gauge wire.

Gauge refers to the size of the conductor in a wire. The higher the gauge number, the smaller the wire. For example, an 18-gauge wire is smaller than a 12-gauge wire. And a 4-gauge wire has more than twice the diameter of a 10-gauge wire.

When the wire size gets larger, the number reaches #0 gauge or 1/0 (one aught). Additional zeros refer to larger sizes. The next larger size above 1/0 is #00 or 2/0 (two aught).

The capacity of a wire reflects the ability it has to carry electrical current. For example, over a distance of 50 feet, a 12-gauge wire can safely carry 10 amps. Over the same distance a 16-gauge wire can carry 3 amps. Choosing the size wire is made easier using a wire size chart.

Just remember the thicker the wire, the smaller the amperage loss.

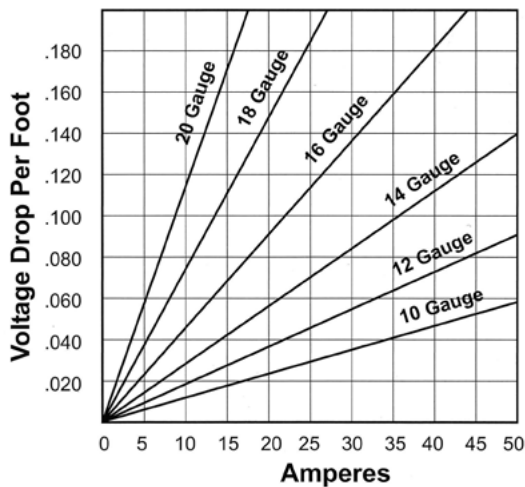

Wire Gauge Chart

GAUGE	S.W.G.	A.W.G. (inches)	A.W.G. (mm)	Actual Size (A.W.G.)
00	0.348	0.368	9,266	●
0	0.324	0.325	8,252	●
1	0.300	0.289	7,348	●
2	0.276	0.258	6,543	●
3	0.252	0.229	5,827	●
4	0.232	0.204	5,189	●
5	0.212	0.182	4,621	●
6	0.192	0.162	4,115	●
7	0.176	0.144	3,665	●
8	0.160	0.129	3,264	●
9	0.144	0.114	2,906	●
10	0.128	0.102	2,588	●
11	0.116	0.091	2,304	●
12	0.104	0.081	2,052	●
13	0.092	0.072	1,829	●
14	0.080	0.064	1,628	●
15	0.072	0.057	1,450	●
16	0.064	0.051	1,291	●
17	0.056	0.045	1,150	●
18	0.048	0.040	1,024	●
19	0.040	0.036	0,912	●
20	0.036	0.032	0,813	●
21	0.032	0.029	0,724	●
22	0.028	0.025	0,643	●

A.W.G. = American Wire Gauge

S.W.G. = Imperial Standard Wire Gauge
 (British legal standard)