

# 01

## CLEARANCE / MARKER LAMPS

*FEUX DE GABARIT / POSITION*

*LÁMPARAS DE GÁLIBO /  
DEMARCADORA*

**MICRONOVA® DOT LED  
CLEARANCE/MARKER LAMP**

Available in PC and P2 versions with .180 bullet or Deutsch® connectors • Sleek aerodynamic styling extends less than 3/8" from mounted surface • No fasteners required

**P2 RATED:**

49322	Red, w/ Grommet	
49322-5	Red, w/ Grommet	<b>RETAIL</b>
49323	Yellow, w/ Grommet	
49323-5	Yellow, w/ Grommet	<b>RETAIL</b>

**PC RATED:**

49452	Red, w/ Bracket	<b>PC</b>
49453	Yellow, w/ Bracket	<b>PC</b>
49332	Red, w/ Grommet	<b>PC</b>
49333	Yellow, P2/PC w/ Grommet	<b>PC</b>
49412	Red, w/ Adapter Bracket	<b>PC</b>
49413	Yellow, w/ Adapter Bracket	<b>PC</b>

**ECE RATED:**

49341	White, w/ Grommet	<b>ECE</b>
49342	Red, w/ Grommet	<b>ECE</b>
49343	Yellow, w/ Grommet	<b>ECE</b>
49351	White, w/ Grommet	<b>ECE</b> <b>24 VOLT</b>
49352	Red, w/ Grommet	<b>ECE</b> <b>24 VOLT</b>
49353	Yellow, w/ Grommet	<b>ECE</b> <b>24 VOLT</b>
60831	White, w/ Grommet and Deutsch® Connector	<b>ECE</b> <b>24 VOLT</b>

**MULTI VOLT:**

49262	Red, w/ Grommet	<b>PC MULTI</b>
49282	Red, w/ Grommet	<b>PC MULTI ECE</b>
49263	Yellow, w/ Grommet	<b>PC MULTI</b>
49283	Yellow, w/ Grommet	<b>PC MULTI ECE</b>
49281	Clear, w/ Grommet	<b>PC MULTI ECE</b>

**Material:** Lens - Acrylic; Bracket - Polycarbonate; Grommet - PVC

**Regulations / Standards:** FMVSS 108, ECE / SAE P2, P3, PC

**Finish:** Red, Yellow, White

**Volts / Amps:** 12V / .05A  
24V / .05A  
9-32V / .03A

**Brackets:** 42110, 94350, 42063

**VMRS Code:** 034-004-253

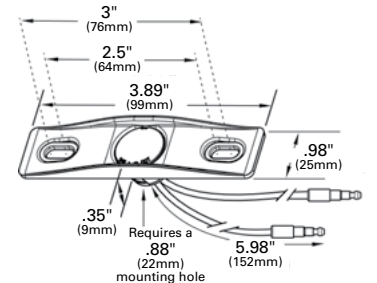
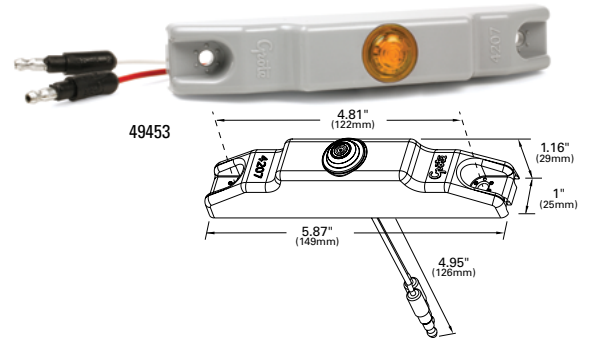
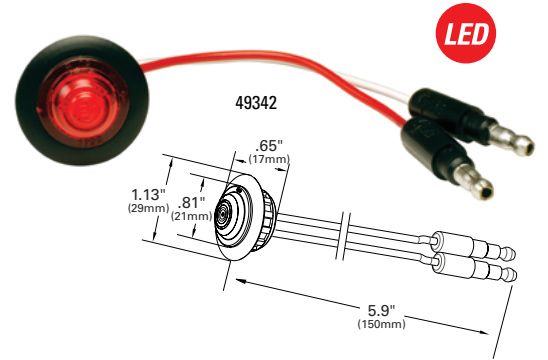

**DUAL INTENSITY MICRONOVA® DOT LED  
CLEARANCE/MARKER LAMP**

Dual Intensity allows for better visibility • Hermetic lens-to-housing seal • Encapsulant potting for total circuit board protection against vibration and corrosion • Sleek aerodynamic styling, small size fits in narrow applications

49362	Red, w/ Grommet, Standard
49363	Yellow, w/ Grommet, Standard

**Material:** Lens - Acrylic; Grommet - PVC

**Regulations / Standards:** FMVSS 108 / SAE P2

**Finish:** Red / Black ; Yellow / Black

**Volts / Amps:** High - 12V / .05A; Low - 12V / .02A;

**VMRS Code:** 034-004-253

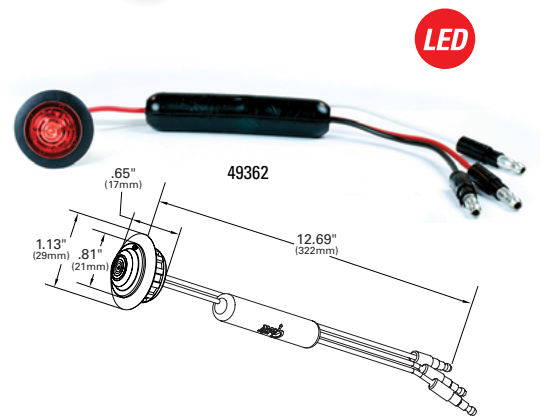

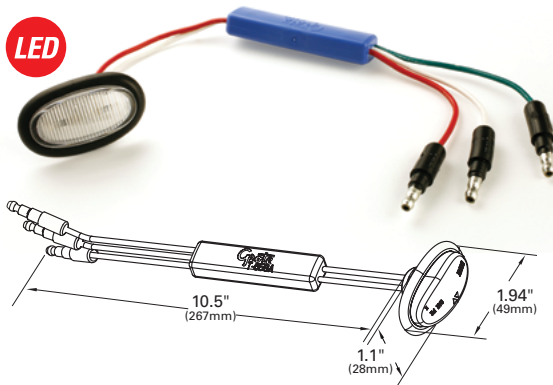
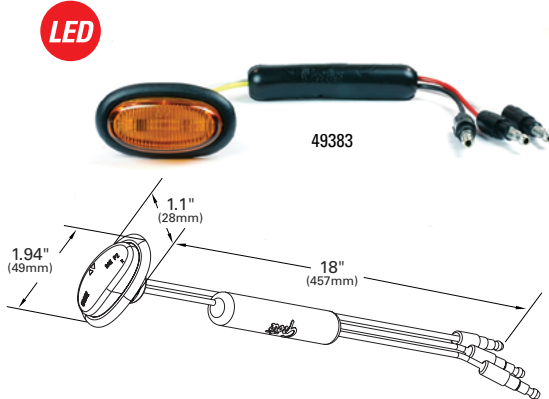
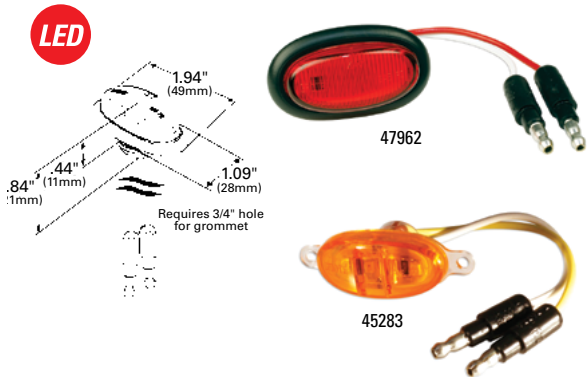

## MICRONOVA® LED CLEARANCE/MARKER LAMP

Low profile makes lamp less susceptible to damage • Small size fits narrow applications • All PC versions meet requirements when mounted at 45° angle

- 47982** Red, Clear Lens w/ Chrome Bezel  
**47952** Red, w/ Chrome Bezel  
**47952-5** Red, w/ Chrome Bezel **RETAIL**  
**47953** Yellow, w/ Chrome Bezel  
**47953-5** Yellow, w/ Chrome Bezel **RETAIL**  
**47983** Yellow, Clear Lens w/ Chrome Bezel  
**47962** Red, w/ Grommet  
**47963** Yellow, w/ Grommet

### PC RATED:

- 45282** Red, Surface Mount **PC**  
**45283** Yellow, Surface Mount **PC**  
**47972** Red, w/ Grommet **PC**  
**47973** Yellow, w/ Grommet **PC**  
**45302** Red, w/ Hardshell **PC**  
**45303** Yellow, w/ Hardshell **PC**

**Material:** Lens - Acrylic; Bracket - Polycarbonate; Grommet - PVC

**Regulations / Standards:** FMVSS 108 / SAE P2, PC

**Finish:** Red / Yellow / Chrome

**Volts / Amps:** 12V / .05A

**Pigtail:** 68580

**Accessory:** Bezel Chrome 93803; Mounting Gasket: 94220

**Bracket:** 42110

**VMRS Code:** 034-004-253

## DUAL INTENSITY MICRONOVA® LED CLEARANCE/MARKER LAMP

Dual Intensity enhances signaling visibility and safety • Small size fits in narrow applications • No exposed fasteners

- 49372** Red, w/ Grommet, Slim-Line .180  
**49373** Yellow, w/ Grommet, Slim-Line .180  
**49382** Red, w/ Grommet, Standard .180  
**49383** Yellow, w/ Grommet, Standard .180

**Material:** Lens - Acrylic; Grommet - PVC

**Regulations / Standards:** FMVSS 108 / SAE P2

**Finish:** Red, Yellow

**Volts / Amps:** 12V / .05A

**Brackets:** 42110

**VMRS Code:** 034-004-253

## MICRONOVA® RED/GREEN INDICATOR LAMP

Suitable for bright sunlight applications • Dual color circuiting molded into pigtail with bullet connectors • Clear lens with Red / Green LEDs • No exposed fasteners

- 49460** Red/Green, Clear Lens w/ Grommet

**Material:** Lens - Clear; Grommet - Polycarbonate

**Ingress Protection:** IP69K

**Volts / Amps:** 12V

**VMRS Code:** 034-004-253



### MICRONOVA® DOT LED INDICATOR LAMP

Durable one-piece LED lamp • No mounting hardware required • Hardwired with .180 standard UBS plug connectors for maximum performance

**60824** Green, w/ Grommet



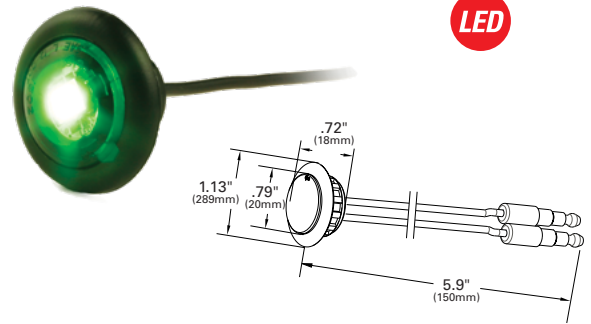

**Material:** Polycarbonate  
**Finish:** Green  
**Voltage Amp:** 12V / .05A  
**Brackets:** 42110, 94350  
**VMRS Code:** 034-004-253



LED

### SUPERNOVA® 2" LED CLEARANCE/MARKER LAMP

Uses same UBS double-seal pigtail as incandescent for quick Plug-and-Go® retrofit • Tin-plated, solid-brass terminals are sealed to housing to resist corrosion and eliminate failure causing leak paths

**47112** Red  
**47113** Yellow  
**47332** Red   
**47333** Yellow   
**46132** Red   
**46133** Yellow 

**ABS LAMP:**

**78433** Yellow

**Material:** Polycarbonate  
**Regulations / Standards:** FMVSS 108 / SAE P2, PC, P3  
**Finish:** Red / Yellow  
**Volts / Amps:** 12V / .06A  
Red - 24V / .03A  
Yellow - 24V / .04A  
**Bracket:** 43690, 43150, 43152, 43153, 43532, 43760, 42180  
**Grommet:** 92120, 92150, 93760  
**Pigtail:** 66851, 67001, 66850, 66801, 67050, 66800, 66840  
**VMRS Code:** 034-004-253



47112

LED

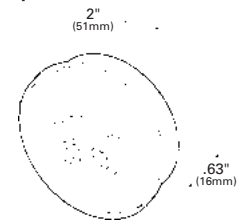

46133

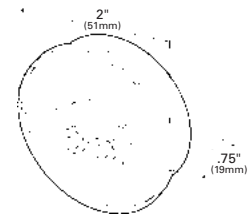

### HI COUNT® 2" 9-DIODE LED CLEARANCE/MARKER LAMP

Uses the same UBS double-seal pigtail as our incandescent version for a quick Plug-and-Go® retrofit • Twist-on mounting for easy installation

**G3002** Red  
**G3002-5** Red   
**G3003** Yellow  
**G3003-5** Yellow 

**Material:** Polycarbonate  
**Regulations / Standards:** FMVSS 108 / SAE P2  
**Finish:** Red / Yellow  
**Volts / Amps:** Red - 12V / .04A,  
Yellow - 12V / .07A  
**Bracket:** 43690, 43150, 43152, 43153, 43532, 43760, 42180  
**Grommet:** 92120, 92150, 93760  
**Pigtail:** 66851, 67001, 66850, 66801, 67050, 66800, 66840  
**VMRS Code:** 034-004-253



G3003

LED

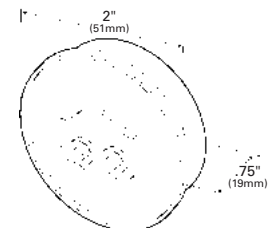



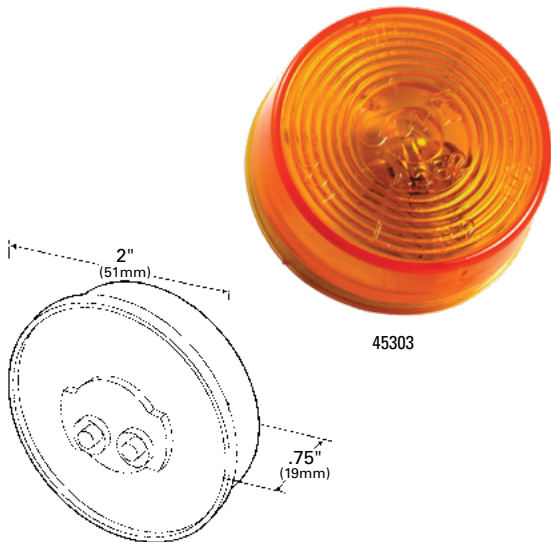

## 2" CLEARANCE/MARKER LAMP

Twist-on mounting for easy installation • Fits all popular mountings and grommets • All versions meet PC requirements when mounted at a 45° angle, recommended bracket 43690

45822	Red	PC
45822-5	Red	PC RETAIL
45823	Yellow	PC
45823-5	Yellow	PC RETAIL

### KITS:

45062	Red (45822 + 92120 + 67050)	PC
45063	Yellow (45823 + 92120 + 67050)	PC

### ABS LAMP:

78333	Yellow	PC
-------	--------	----

**Material:** Polycarbonate  
**Regulations / Standards:** FMVSS 108 / SAE P2, P3, PC, PC2  
**Finish:** Red / Yellow  
**Volts / Amps:** Bulb 2 CP: 12V / .33A  
**Bracket:** 43690, 43150, 43152, 43153, 43532, 43760, 42180  
**Grommet:** 92120, 92150, 93760  
**Pigtail:** 66851, 67001, 66850, 66801, 67050, 66800, 66840  
**VMRS Code:** 034-004-021

## SUPERNOVA® 2" BEEHIVE LED CLEARANCE/MARKER LAMP

Tin-plated, solid-brass terminals are sealed to housing to resist corrosion and eliminate failure causing leak paths • Uses same UBS double-seal pigtail as incandescent for a quick Plug-and-Go® retrofit

47212	Red
47213	Yellow

**Material:** Polycarbonate  
**Regulations / Standards:** FMVSS 108 / SAE P2  
**Finish:** Red / Yellow  
**Volts / Amps:** 12V / .06A  
**Bracket:** 43690, 43150, 43152, 43153, 43532, 43760, 42180  
**Grommet:** 92120, 92150, 93760  
**Pigtail:** 66851, 67001, 66850, 66801, 67050, 66800, 66840  
**VMRS Code:** 034-004-253

## HI COUNT® 2" 9-DIODE BEEHIVE LED CLEARANCE/MARKER LAMP

Uses the same UBS double-seal pigtail as the incandescent version for a quick Plug-and-Go® retrofit • Twist-on mounting for easy installation • Fits all popular mountings and grommets

G3092	Red	PC
G3093	Yellow	PC

**Material:** Polycarbonate  
**Regulations / Standards:** FMVSS 108 / SAE P2, PC  
**Finish:** Red / Yellow  
**Volts / Amps:** Red - 12V / .04A, Yellow - 12V / .07A  
**Bracket:** 43690, 43150, 43152, 43153, 43532, 43760, 42180  
**Grommet:** 92120, 92150, 93760  
**Pigtail:** 66851, 67001, 66850, 66801, 67050, 66800, 66840  
**VMRS Code:** 034-004-253

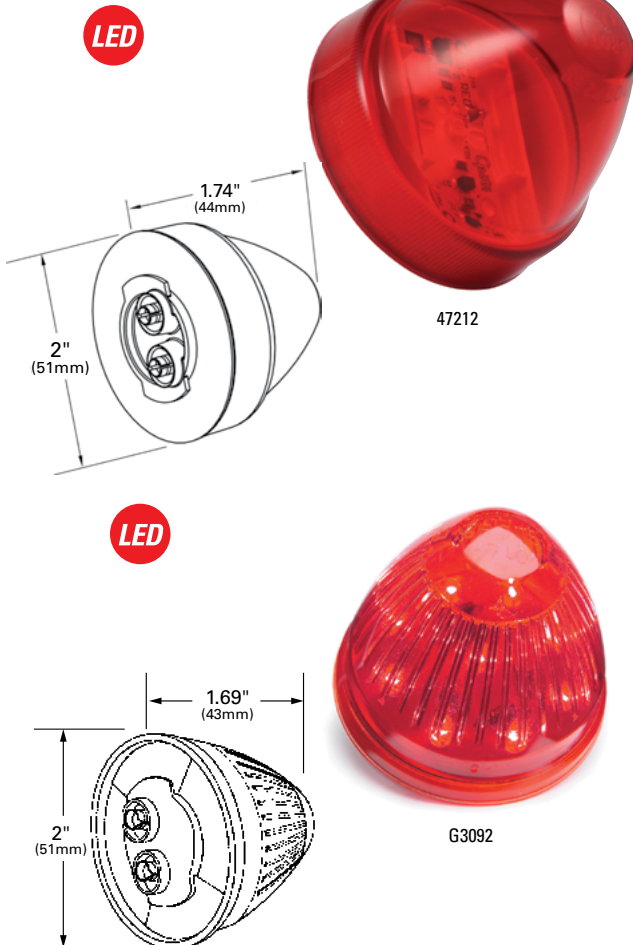

## 2" BEEHIVE CLEARANCE/MARKER LAMP

Fits popular grommet and bracket mountings • Twist-on mounting for easy installation • Meets PC function only when mounted at a 45° angle, recommended bracket 43690

- 47102 Red **PC**
- 47103 Yellow **PC**

**Material:** Polycarbonate  
**Regulations / Standards:** FMVSS 108 / SAE P2, PC  
**Finish:** Red / Yellow  
**Bulb:** 2 CP  
**Volts / Amps:** 12V / .33A  
**Bracket:** 43690, 43150, 43152, 43153, 43532, 43760, 42180  
**Grommet:** 92120, 92150, 93760  
**Pigtail:** 66851, 67001, 66850, 66801, 67050, 66800, 66840  
**VMRS Code:** 034-004-021



47103

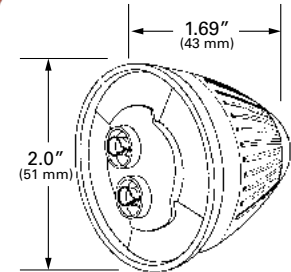

## SUPERNOVA® 2 1/2" LED CLEARANCE/MARKER LAMP

Uses same UBS double-seal pigtail as incandescent version for a quick Plug-and-Go® retrofit • Tin-plated, solid-brass terminals are sealed to housing, to resist corrosion and eliminate failure causing leak paths

- 47122 Red
- 47123 Yellow
- 47202 Red w/ Black, Theft-Resistant Flange
- 47322 Red **24 VOLT**
- 47323 Yellow **24 VOLT**
- 46142 Red **PC**
- 46143 Yellow **PC**

**KITS:**

- 47472 Red (47122 + 91400 + 67001)
- 47473 Yellow (47123 + 91400 + 67001)

**ABS LAMP:**

- 78423 Yellow

**Material:** Polycarbonate  
**Regulations / Standards:** FMVSS 108 / SAE P2, PC, P3  
**Finish:** Red / Yellow  
**Volts / Amps:** 12V / .06A  
                     24V / .03A  
**Bracket:** 43690, 43160, 43162, 43163, 43512, 43522, 93750, 42180, 42170  
**Grommet:** 91400, 91410, 92070, 91890, 91880, 92920  
**Pigtail:** 66851, 67001, 66850, 66801, 67050, 66800, 66840  
**VMRS Code:** 034-004-253



47123

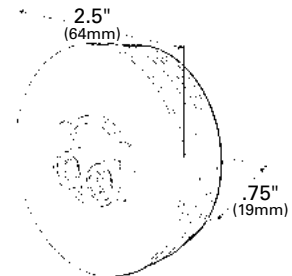

46142

LED

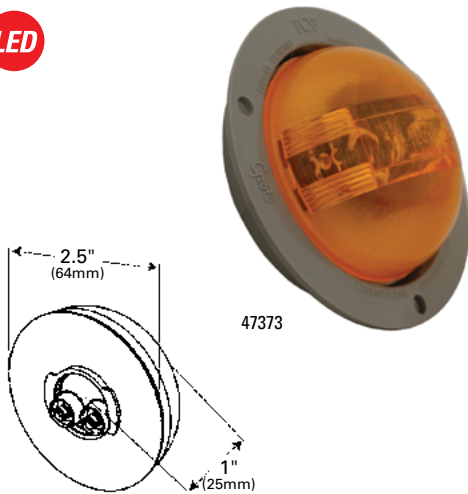
**SUPERNOVA® 2 1/2" PC RATED, LED CLEARANCE/MARKER LAMP**

Uses same UBS double-seal pigtail as incandescent for a quick Plug-and-Go® retrofit • Tin-plated, solid-brass terminals are sealed to housing, to resist corrosion and eliminate failure-causing leak paths • Available with lamp sealed to flange, for direct mounting in the side of a trailer, eliminating a leak-path into the trailer

<b>47232</b>	Red	<b>PC</b>
<b>47233</b>	Yellow	<b>PC</b>

**SEALED FLANGE APPLICATIONS:**

<b>47372</b>	Red w/ Gray Theft-Resistant Flange	<b>PC</b>
<b>47373</b>	Yellow w/ Gray Theft-Resistant Flange	<b>PC</b>

**Material:** Polycarbonate**Regulations / Standards:** FMVSS 108 / SAE P2, P3, PC**Finish:** Red / Yellow**Volts / Amps:** 12V / .06A**Bracket:** 43690, 43160, 43162, 43163, 43512, 43522, 93750, 42180, 42170**Grommet:** 91400, 91410, 92070, 91890, 91880, 92920**Pigtail:** 66851, 67001, 66850, 66801, 67050, 66800, 66840**VMRS Code:** 034-004-253

LED

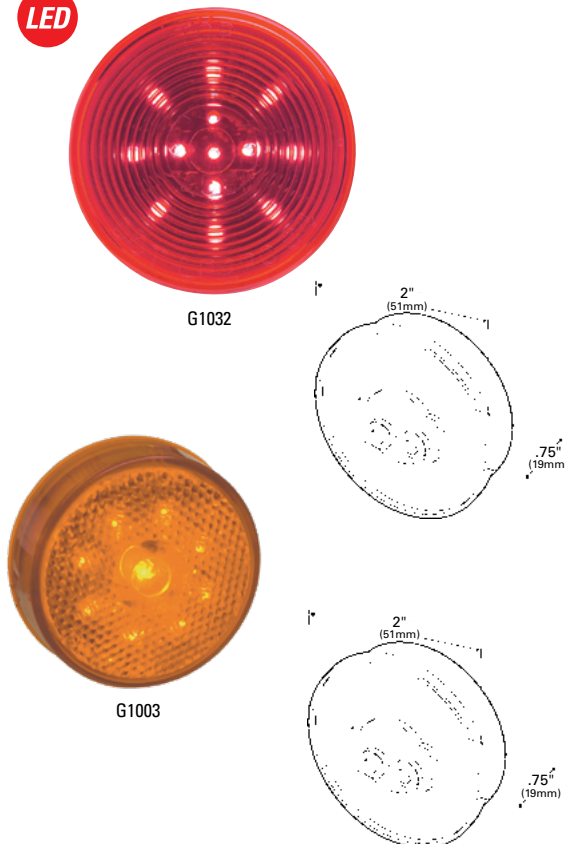
**HI COUNT® 2 1/2" 9-DIODE LED CLEARANCE/MARKER LAMP**

Uses the same UBS double-seal pigtail as the incandescent version for a quick Plug-and-Go® retrofit • Twist-on mounting for easy installation • Fits all popular mountings and grommets

**OPTIC LENS:**

<b>G1032</b>	Red	
<b>G1032-5</b>	Red	<b>RETAIL</b>
<b>G1033</b>	Yellow	
<b>G1033-5</b>	Yellow	<b>RETAIL</b>
<b>G1042</b>	Red, Clear Lens	
<b>G1043</b>	Yellow, Clear Lens	

**REFLEX LENS:**

<b>G1002</b>	Red
<b>G1003</b>	Yellow

**Material:** Polycarbonate**Regulations / Standards:** FMVSS 108 / Optic - SAE P2, Reflex - SAE A, P2**Finish:** Red / Yellow**Volts / Amps:** Red - 12V / .04A,  
Yellow - 12V / .07A**Bracket:** 43690, 43160, 43162, 43163, 43512, 43522, 93750, 42180, 42170**Grommet:** 91400, 91410, 92070, 91890, 91880, 92920**Pigtail:** 66851, 67001, 66850, 66801, 67050, 66800, 66840**VMRS Code:** 034-004-253



## HI COUNT® 2½" 9-DIODE LED CLEARANCE/MARKER LAMP

Uses the same UBS double-seal pigtail as our incandescent version for a quick Plug-and-Go® retrofit • Twist-on mounting for easy installation  
 • Fits all popular mountings and grommets

- G1092** Red
- G1093** Yellow

**Material:** Polycarbonate  
**Regulations / Standards:** FMVSS 108 / SAE P2  
**Finish:** Red / Yellow  
**Volts / Amps:** 12V / .09A  
**Bracket:** 43690, 43160, 43162, 43163, 43512, 43522, 93750, 42180, 42170  
**Grommet:** 91400, 91410, 92070, 91890, 91880, 92920  
**Pigtail:** 66851, 67001, 66850, 66801, 67050, 66800, 66840  
**VMRS Code:** 034-004-253



G1093

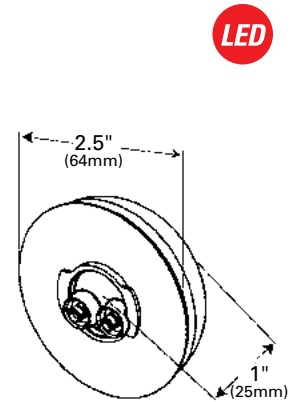

## 2½" CLEARANCE/MARKER LAMP

Hermetic lens-to-housing seal • Twist-on mounting for easy installation  
 • Fits all popular mountings and grommets • Optic lens versions meet PC function only when mounted at a 45° angle, recommended bracket: 43690; grommets: 91890 or 92920

**OPTIC LENS:**

- 45812** Red **PC**
- 45812-5** Red **PC RETAIL**
- 45813** Yellow **PC**
- 45813-5** Yellow **PC RETAIL**

**OPTIC LENS KITS:**

- 45042** Red (45812 + 91400 + 67050) **PC**
- 45043** Yellow (45813 + 91400 + 67050) **PC**

**REFLEX LENS:**

- 45832** Red
- 45833** Yellow

**BUILT-IN REFLECTOR KITS:**

- 45072** Red (45832 + 91400 + 67050)
- 45073** Yellow (45833 + 91400 + 67050)

**ABS LAMP:**

- 78343** Yellow, Optic Lens **PC**

**Material:** Lens - Acrylic; Housing - Polycarbonate  
**Regulations / Standards:** FMVSS 108 / Optic - SAE P2, P3, PC, PC2; Reflex - SAE A, P2, P3  
**Finish:** Red / Yellow  
**Volts / Amps:** Bulb: 2 CP: 12V / .33A  
 Bulb: 3 CP; Volts / Amps: 24V / .17A  
**Bracket:** 43690, 43160, 43162, 43163, 43512, 43522, 93750, 42180, 42170  
**Grommet:** 91400, 91410, 92070, 91890, 91880, 92920  
**Pigtail:** 66851, 67001, 66850, 66801, 67050, 66800, 66840  
**VMRS Code:** 034-004-021



45812

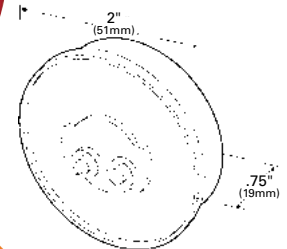

45833

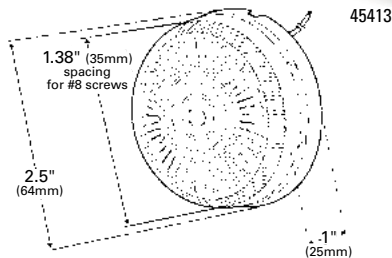
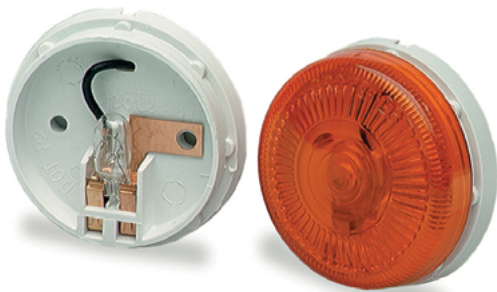

## 2 1/2" SURFACE MOUNT SINGLE-BULB CLEARANCE/MARKER LAMP

Snap-on lens for easy bulb replacement • OE replacement on Mack® MR models • Meets PC function only when mounted at a 45° angle

45412	Red	<b>PC</b>
45412-5	Red	<b>PC RETAIL</b>
45413	Yellow	<b>PC</b>
45413-5	Yellow	<b>PC RETAIL</b>

**Material:** Polypropylene / Acrylic

**Regulations / Standards:** FMVSS 108 / SAE P2, PC

**Finish:** Red / Yellow

**Bulb:** #193, 2 CP

**Volts / Amps:** 12V / .33A

**Lens:** Red 90162, Yellow 90163

**VMRS Code:** 034-004-021

LED

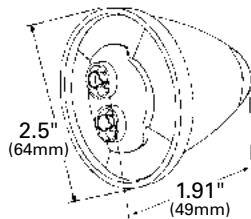

## SUPERNOVA® 2 1/2" BEEHIVE LED CLEARANCE/MARKER LAMP

Tin-plated, solid-brass terminals are sealed to housing to resist corrosion and eliminate failure-causing leak paths • Uses same UBS double-seal pigtail as incandescent for a quick Plug-and-Go® retrofit

47222	Red
47223	Yellow

**Material:** Polycarbonate

**Regulations / Standards:** FMVSS 108 / SAE P2

**Finish:** Red / Yellow

**Volts / Amps:** 12V / .06A

**Bracket:** 43690, 43160, 43162, 43163, 43512, 43522, 93750, 42180, 42170

**Grommet:** 91400, 91410, 92070, 91890, 91880, 92920

**Pigtail:** 66851, 67001, 66850, 66801, 67050, 66800, 66840

**VMRS Code:** 034-004-253

LED

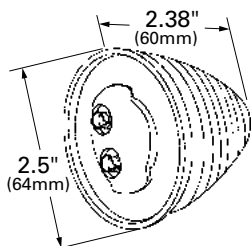

## HI COUNT® 2 1/2" 9-DIODE BEEHIVE LED CLEARANCE/MARKER LAMP

Twist-on mounting for easy installation • Fits all popular mountings and grommets

G1082	Red
G1083	Yellow

**Material:** Polycarbonate

**Regulations / Standards:** FMVSS 108 / SAE P2

**Finish:** Red / Yellow

**Volts / Amps:** Red - 12V / .04A,  
Yellow - 12V / .07A

**Bracket:** 43690, 43160, 43162, 43163, 43512, 43522, 93750, 42180, 42170

**Grommet:** 91400, 91410, 92070, 91890, 91880, 92920

**Pigtail:** 66851, 67001, 66850, 66801, 67050, 66800, 66840

**VMRS Code:** 034-004-253

### 2 1/2" BEEHIVE CLEARANCE/MARKER LAMP

Twist-on mounting for easy installation • Fits all popular mountings and grommets • All PC versions meet requirements when mounted at 45° angle

- 45322 Red **PC**
- 45323 Yellow **PC**

**Material:** Polycarbonate  
**Regulations / Standards:** FMVSS 108 / SAE P2, PC  
**Finish:** Red / Yellow  
**Bulb:** 2 CP  
**Volts / Amps:** 12V / .33A  
**Bracket:** 43690, 43160, 43162, 43163, 43512, 43522, 93750, 42180, 42170  
**Grommet:** 91400, 91410, 92070, 91890, 91880, 92920  
**Pigtail:** 66851, 67001, 66850, 66801, 67050, 66800, 66840  
**VMRS Code:** 034-004-021



45323

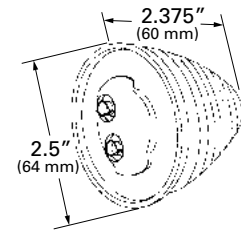

### BEEHIVE CLEARANCE/MARKER LAMP WITH FIXED-ANGLE MOUNTING BRACKET

Wide light-diffusion optic design • Fade-resistant, snap-on acrylic lens  
 • Bracket is permanently attached • Meets PC function only when mounted at a 45° angle

- 45022 Red **PC**
- 45023 Yellow **PC**

**Material:** ABS / Steel / Acrylic  
**Regulations / Standards:** FMVSS 108 / SAE P2, PC  
**Finish:** Red / Yellow  
**Bulb:** #67, 4 CP  
**Volts / Amps:** 12V / .59A  
**Lens:** Yellow 90303  
**VMRS Code:** 034-004-021



45023

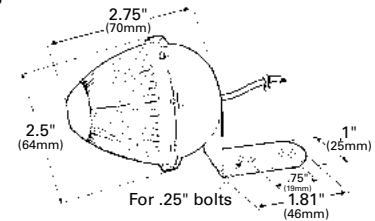

### 2 1/2" OVAL LED CLEARANCE/MARKER LAMP

Surface mount design for easy installation • Self-grounding eyelet grounds lamp when attached to metal plate (47012 and 47013)

- 45002-5 Red **RETAIL**
- 45003-5 Yellow **RETAIL**

**SELF GROUNDING:**

- 47012 Red
- 47013 Yellow

**Material:** Polycarbonate  
**Regulations / Standards:** FMVSS 108 / SAE P2, P3  
**Finish:** Red / Yellow  
**Volts / Amps:** 12V / .05A  
**VMRS Code:** 034-004-253

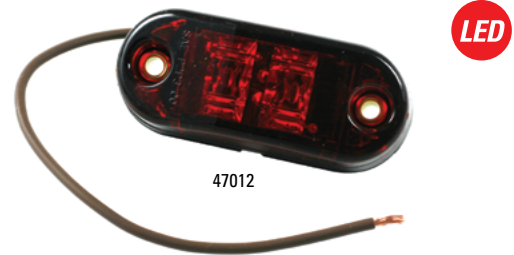

47012

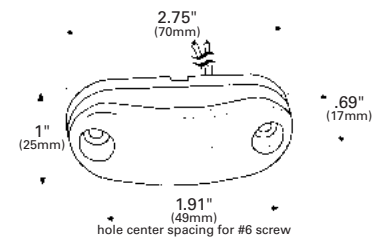



LED



47082

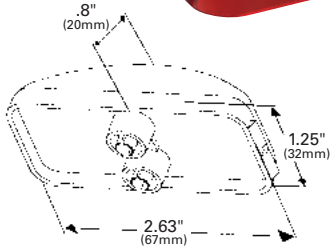

### SUPERNOVA® LED CLEARANCE/MARKER LAMP

Tin-plated, solid-brass terminals are sealed to housing, to resist corrosion and eliminate failure-causing leak paths • Uses the same UBS double-seal pigtail as incandescent for a quick Plug-and-Go® retrofit

<b>47082</b>	Red
<b>47083</b>	Yellow
<b>47084</b>	Green

**Material:** Polycarbonate  
**Regulations / Standards:** FMVSS 108 / SAE P2 (N/A Green)  
**Finish:** Red / Yellow / Green  
**Volts / Amps:** 12V / .06A  
**Bracket:** 43970, 43980, 94233, 43380  
**Grommet:** 91380  
**Pigtail:** 66851, 67001, 66850, 66801, 67050, 66800, 66840  
**VMRS Code:** 034-004-253

LED



G1503

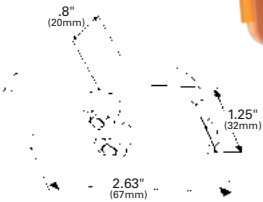

### HI COUNT® 3-DIODE LED CLEARANCE/MARKER LAMP

Uses the same UBS double-seal pigtail as the incandescent version for a quick Plug-and-Go® retrofit • Fits popular mountings and grommets

<b>G1502</b>	Red
<b>G1503</b>	Yellow

**Material:** Polycarbonate  
**Regulations / Standards:** FMVSS 108 / SAE P2  
**Finish:** Red / Yellow  
**Volts / Amps:** 12V / .06A  
**Bracket:** 43970, 43980, 94233, 43380  
**Grommet:** 91380  
**Pigtail:** 66851, 67001, 66850, 66801, 67050, 66800, 66840  
**VMRS Code:** 034-004-253



46412

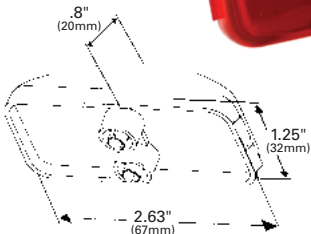

### CLEARANCE/MARKER LAMP

Uses double-seal UBS pigtail • Meets PC function only when mounted at a 45° angle, recommend bracket 43380

<b>45162</b>	Red	<b>PC</b> <b>24 VOLT</b>
<b>46412</b>	Red	<b>PC</b>
<b>46412-5</b>	Red, Pair Pack	<b>PC</b> <b>RETAIL</b>
<b>46413</b>	Yellow	<b>PC</b>
<b>46413-5</b>	Yellow, Pair Pack	<b>PC</b> <b>RETAIL</b>

#### KITS:

<b>46422-5</b>	Red (43980 + 67050)	<b>PC</b>
<b>46423-5</b>	Yellow (43980 + 67050)	<b>PC</b>

**Material:** Polycarbonate  
**Regulations / Standards:** FMVSS 108 / SAE P2, PC  
**Finish:** Red / Yellow  
**Volts / Amps:** Bulb: 2 CP: 12V / .33A; Bulb: 3 CP: 24V / .17A  
**Bracket:** 43970, 43980, 94233, 43380  
**Grommet:** 91380;  
**Pigtail:** 66851, 67001, 66850, 66801, 67050, 66800, 66840  
**VMRS Code:** 034-004-021

**SUPERNOVA® LED  
 CLEARANCE/MARKER LAMP**

Uses same UBS pigtail as incandescent for a quick Plug-and-Go® retrofit  
 • Meets PC function only when mounted at a 45° angle

**P2 RATED::**

- 47092** Red
- 47093** Yellow

**KITS:**

- 65202** Red (47092 + 43850)
- 65203** Yellow (47093 + 43850)

**PC RATED:**

- 47492** Red **PC**
- 47493** Yellow **PC**

**Material:** Polycarbonate  
**Regulations / Standards:** FMVSS 108 / SAE P2, PC  
**Finish:** Red / Yellow  
**Volts / Amps:** P2 Rated - 12V / .06A; PC Rated - 12V / .12A  
**Accessory:** Lamp Guard: 43120  
**Bracket:** 43780, 43783, 43850  
**Pigtail:** 66982, 66980, 66981  
**VMRS Code:** 034-004-253

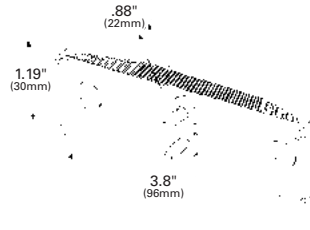
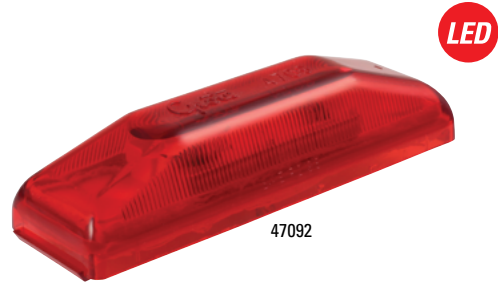

**HI COUNT® 3-DIODE LED  
 CLEARANCE/MARKER LAMP**

Hermetic lens-to-housing seal • Uses the same UBS double-seal pigtail as the incandescent version for a quick Plug-and-Go® retrofit • Fits all popular mountings and grommets

- G1902** Red
- G1902-5** Red **RETAIL**
- G1903** Yellow
- G1903-5** Yellow **RETAIL**

**Material:** Polycarbonate  
**Regulations / Standards:** FMVSS 108 / SAE P2  
**Finish:** Red / Yellow  
**Volts / Amps:** 12V / .06A  
**Accessory:** Lamp Guard: 43120; Bracket: 43780, 43783, 43850  
**Pigtail:** 66982, 66980, 66981  
**VMRS Code:** 034-004-253

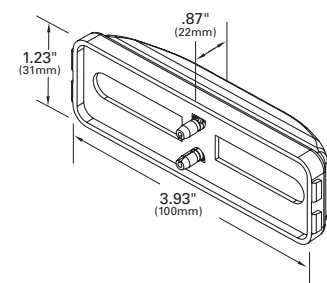
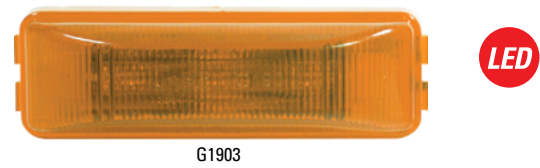



46743



46740

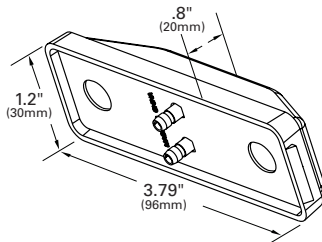

LED



47502

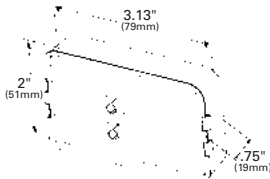

45233

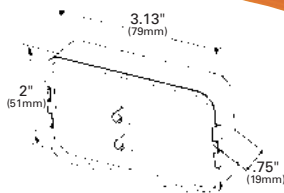

## CLEARANCE/MARKER LAMP

Narrow mounting applications • Hermetic lens-to-housing seal  
• Meets PC function only when mounted at a 45° angle

46742 Red **PC**  
46743 Yellow **PC**

### KITS:

45092 Red (46742 + 43850) **PC**  
45093 Yellow (46743 + 43850) **PC**

### ABS LAMP:

78393 Yellow **PC**

### SPLIT LENS COLOR

46740 Red & Yellow

**Material:** Polycarbonate  
**Regulations / Standards:** FMVSS 108 / SAE P2, P3, PC, PC2, (46740) - SAE P2  
**Finish:** Red / Yellow  
**Volts / Amps:** Bulb (2) 2 CP: 12V / .66A  
Bulb (2) 3 CP: 24V / .34A  
**Accessory:** Lamp Guard: 43120  
**Bracket:** 43780, 43783, 43850  
**Pigtail:** 66980, 66982, 66981  
**VMRS Code:** 034-004-021

## SUPERNOVA® LED CLEARANCE/MARKER LAMP WITH BUILT-IN REFLECTOR

Encapsulant potting for total circuit board protection • Tin-plated, solid-brass terminals are sealed to housing, to resist corrosion and eliminate failure-causing leak paths

47502 Red  
47503 Yellow

**Material:** Polycarbonate  
**Regulations / Standards:** FMVSS 108 / SAE A, P2  
**Finish:** Red / Yellow  
**Volts / Amps:** 12V / .06A  
**Grommet:** 93400, 93402  
**Pigtail:** 66851, 67001, 66850, 66801, 67050, 66800, 66840  
**VMRS Code:** 034-004-253

## CLEARANCE/MARKER LAMP WITH BUILT-IN REFLECTOR

Fits popular grommets, pigtails and harnesses

45232 Red  
45233 Yellow

**Material:** Polycarbonate  
**Regulations / Standards:** FMVSS 108 / SAE A, P2  
**Finish:** Red / Yellow  
**Volts / Amps:** Bulb: 2 CP; 12V / .33A  
**Grommet:** 93400, 93402  
**Pigtail:** 66851, 67001, 66850, 66801, 67050, 66800, 66840  
**VMRS Code:** 034-004-021



**SUPERNOVA® 3" THIN-LINE LED CLEARANCE/MARKER LAMP**

3" mounting center • Field-replaceable lens • Anti-torque design protects against over tightening and lens cracking • Wire exit holes at ends allow for flow-through harnessing • All PC versions meet requirements when mounted at a 45° angle

- 47242 Red
- 47243 Yellow
- 47362 Red

**KITS:**

- 65512 Red (47242 + 66930)
- 65513 Yellow (47243 + 66930)

**PC RATED:**

- 47462 Red
- 47463 Yellow

**ABS LAMP:**

- 78453 Yellow

**Material:** Polycarbonate  
**Regulations / Standards:** FMVSS 108 / SAE P2, PC  
**Finish:** Red / Yellow  
**Volts / Amps:** 12V / .06A (47242, 47243, 78453), 12V / .12A (47462, 47463)  
 Red - 24V / .03A; Yellow - 24V / .04A  
**Pigtail:** 66931, 66930, 66932  
**VMRS Code:** 034-004-253



LED

47243



47462

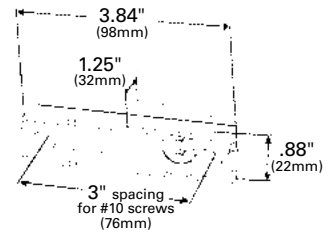

**SUPERNOVA® 3" THIN-LINE DUAL INTENSITY LED CLEARANCE/MARKER LAMP**

3" mounting center • Multi-function lamp enhances signaling visibility and safety • Compact size for narrow mounting locations • Lamp functions as a marker, clearance, identification and supplemental high-mount stop or turn lamp

- 49252 Red
- 49253 Yellow

**Material:** Polycarbonate  
**Regulations / Standards:** FMVSS 108 / SAE P2, PC  
**Finish:** Red / Yellow  
**Volts / Amps:** 14V / .02A, .06A  
**Pigtail:** 66870  
**VMRS Code:** 034-004-253



LED

49252

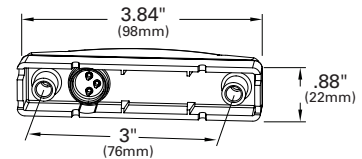

LED

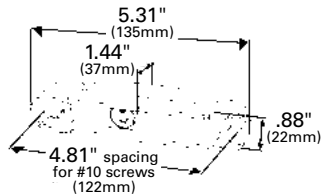

### SUPERNOVA® THIN-LINE LED CLEARANCE/ MARKER LAMP

Sealed marker lamp • Encapsulant potting for total circuit board protection  
• Thin-Line design fits narrow rails and channels • Uses UBS double-seal pigtail for maximum protection against corrosion

**46933** Yellow Lens, Yellow Body

**Material:** Polycarbonate  
**Regulations / Standards:** FMVSS 108 / SAE P2  
**Finish:** Yellow  
**Volts / Amps:** 12V / .07A  
**Bracket:** 43074  
**Pigtail:** 66931, 66930, 66932  
**VMRS Code:** 034-004-253



45252

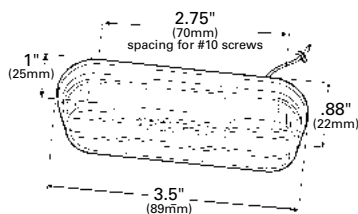

### THIN-LINE SINGLE-BULB CLEARANCE/ MARKER LAMP

Narrow rail and channel mounting • Snap-on lens for easy bulb replacement • Attached pigtail

**45252** Red  
**45252-5** Red **RETAIL**  
**45253** Yellow  
**45253-5** Yellow **RETAIL**

**Material:** Lens - Acrylic; Housing - Polycarbonate  
**Regulations / Standards:** FMVSS 108 / SAE P2  
**Finish:** Red / Yellow  
**Bulb:** #193, 2 CP  
**Volts / Amps:** 12V / .33A  
**Lens:** Red 90152, Yellow 90153  
**VMRS Code:** 034-004-021



45512

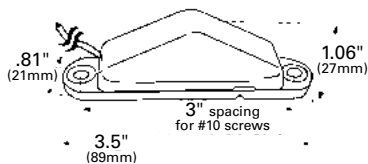

### CLEARANCE/MARKER LAMP WITH PEAK LENS

Shock-resistant bulb mount • Snap-on lens for easy bulb replacement  
All PC versions meet requirements when mounted at a 45° angle

#### BLUNT CUT:

**45512** Red **PC**  
**45513** Yellow **PC**

**Material:** Polycarbonate  
**Regulations / Standards:** FMVSS 108 / SAE P2, PC  
**Finish:** Red / Yellow  
**Bulb:** #194, 2 CP  
**Volts / Amps:** 12V / .27A  
**Lens:** Red 93252  
**VMRS Code:** 034-004-021

### ECONOMY CLEARANCE/MARKER LAMP

Snap-on lens for easy bulb replacement • Brass, ground eyelet • Compact design

- 46882 Red
- 46882-5 Red **RETAIL**
- 46883 Yellow
- 46883-5 Yellow **RETAIL**

**Material:** Lens - Polycarbonate; Housing - Polypropylene  
**Regulations / Standards:** FMVSS 108 / SAE P2  
**Finish:** Red / Yellow  
**Volts / Amps:** Bulb #194, 2 CP: 12V / .27A  
**Lens:** Red 92432, Yellow 92433  
**VMRS Code:** 034-004-021

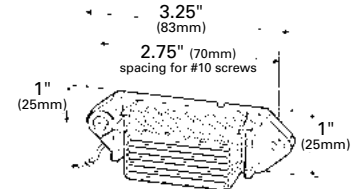

### RECTANGULAR SINGLE-BULB CLEARANCE/MARKER LAMP WITH BUILT-IN REFLECTOR

Corrosion-resistant body • Flange mounting • Boat, snowmobile, trailer, and RV applications

- 46392 Red
- 46393 Yellow
- 46393-5 Yellow **RETAIL**

**Material:** Lens - Acrylic; Housing - Polypropylene  
**Regulations / Standards:** FMVSS 108 / SAE A, P2, P3  
**Finish:** Red / Yellow  
**Volts / Amps:** 12V / .27A  
**Lens:** Red 91112, Yellow 91113  
**VMRS Code:** 034-004-021

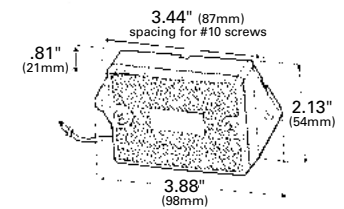
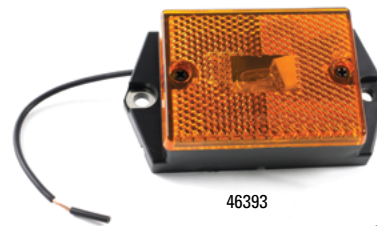

### RECTANGULAR SUBMERSIBLE CLEARANCE/MARKER LAMP WITH BUILT-IN REFLECTOR

Used with a large variety of boat, snowmobile and utility trailer lighting kits

- 46982-5 Red, Clearance/Marker **RETAIL**
- 46983-5 Yellow, Clearance/Marker **RETAIL**

**Material:** Lens - Acrylic; Housing - ABS  
**Regulations / Standards:** FMVSS 108 / SAE P2, A  
**Finish:** Red / Yellow  
**Volts / Amps:** 12V / .27A  
**Lens:** Red: 91112, Yellow 91113  
**VMRS Code:** 034-004-021

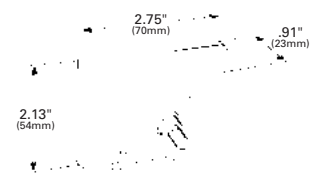
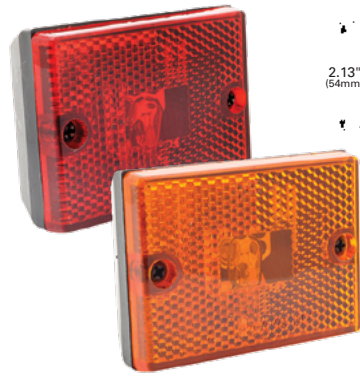

### RECTANGULAR CLEARANCE/MARKER LAMP

Chrome-plated, polycarbonate housing • 2" mounting centers  
 • 1 1/8" socket hole required

- 47052 Red
- 47053 Yellow

**Material:** Lens - Acrylic; Housing - Polycarbonate  
**Regulations / Standards:** FMVSS 108 / SAE P2  
**Finish:** Chrome / Red / Yellow  
**Volts / Amps:** Bulb #1895, 2 CP: 12V / .27A  
**VMRS Code:** 034-004-021

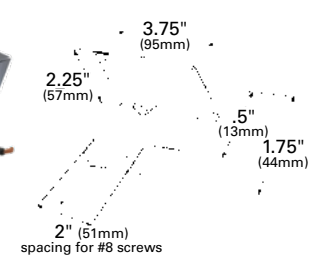



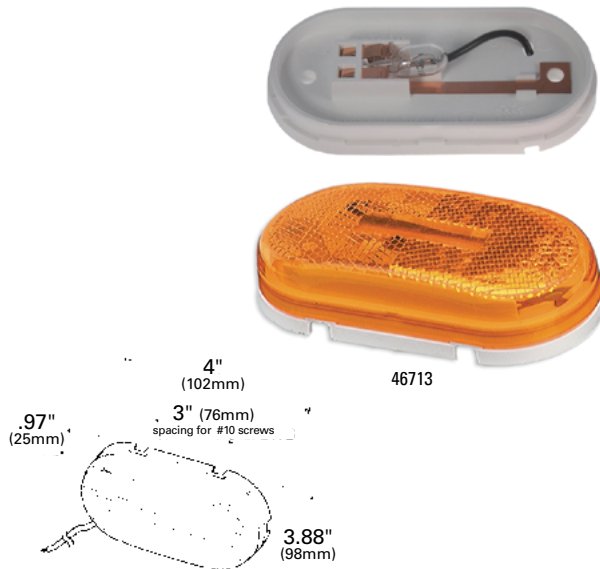

### SINGLE-BULB OVAL CLEARANCE/MARKER LAMP

Snap-on lens • Corrosion-resistant contact and ground • Reflex version is a combined side marker, clearance lamp, and reflector

#### OPTIC LENS:

46703 Yellow

#### BUILT-IN REFLECTOR:

46712 Red

46712-5 Red **RETAIL**

46713 Yellow

46713-5 Yellow **RETAIL**

**Material:** Lens - Acrylic; Housing - Polypropylene

**Regulations / Standards:** FMVSS 108 / Optic - SAE P2; Reflex - SAE A, P2

**Finish:** Red / Yellow

**Bulb:** #193, 2 CP

**Volts / Amps:** 12V / .33A

**Bracket:** 43144, 43673

**Lens:** Optic - Red 90122, Yellow 90123; Reflex - Red 90202, Yellow 90203

**VMRS Code:** 034-004-021

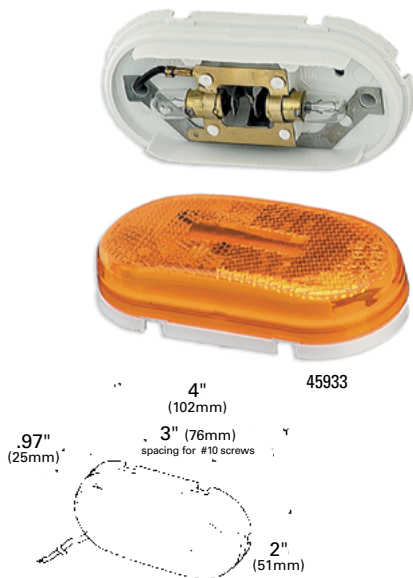

### TWO-BULB OVAL PIGTAIL-TYPE CLEARANCE/MARKER LAMP

Standard snap-on lens for easy bulb replacement • Two stainless steel grounds • Exclusive internal armor for additional bulb protection • Corrosion-resistant contacts • Reflex version is a combined side marker, clearance lamp, and reflector • Optic lens version meets PC function only when mounted at a 45° angle

#### OPTIC LENS:

45262 Red **PC**

45263 Yellow **PC**

#### BUILT-IN CLASS "A" REFLECTOR:

45932 Red

45933 Yellow

**Material:** Lens - Acrylic; Housing - Polypropylene

**Regulations / Standards:** FMVSS 108 / Optic - SAE P2, PC; Reflex - SAE A, P2

**Finish:** Red / Yellow

**Bulb:** (2) #1893, 2 CP

**Volts / Amps:** 12V / .66A

**Bracket:** 43144, 43673

**Pigtail:** 67120

**Lens:** Optic - Red 91572, Yellow 91573; Reflex - Red 90202, Yellow 90203

**VMRS Code:** 034-004-021

**TWO-BULB NO-SPLICE CLEARANCE/MARKER LAMP**

No-splice wiring system • Internal armor for additional protection  
 • Standard snap-on lens for easy bulb replacement • Meets PC function only when mounted at a 45° angle

- 45432 Red **PC**
- 45433 Yellow **PC**

**Material:** Lens - Acrylic; Housing - Polypropylene  
**Regulations / Standards:** FMVSS 108 / SAEP2, P3, PC  
**Finish:** Red / Yellow  
**Volts / Amps:** Bulb (2) #1893, 2 CP: 12V / .66A  
**Bracket:** 43144, 43673  
**Lens:** Red 91572, Yellow 91573  
**VMRS Code:** 034-004-021

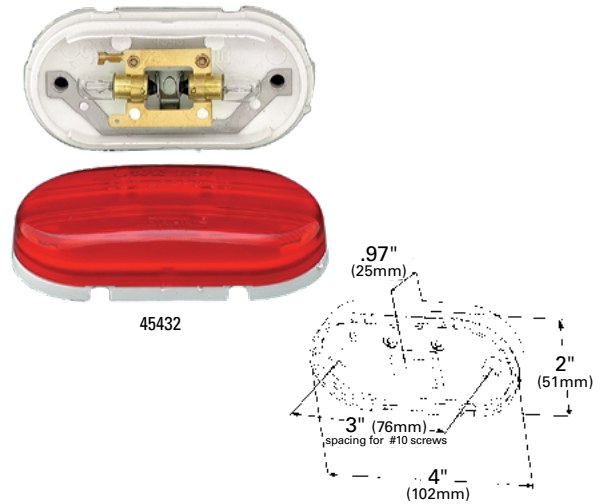

**HI COUNT® SQUARE-CORNER 13-DIODE LED CLEARANCE/MARKER LAMP**

Molded snap-ring • Potted for total circuit board protection  
 • Field-replaceable lens

- G4602 Red
- G4602-5 Red **RETAIL**
- G4603 Yellow
- G4603-5 Yellow **RETAIL**

**Material:** Lens - Acrylic; Housing - Polycarbonate  
**Regulations / Standards:** FMVSS 108 / SAE P2  
**Finish:** Red / Yellow  
**Volts / Amps:** 12V / .15A  
**Bracket:** 43144, 43673  
**Lens:** Red 91962, Yellow 91963, Clear 91961  
**VMRS Code:** 034-004-253

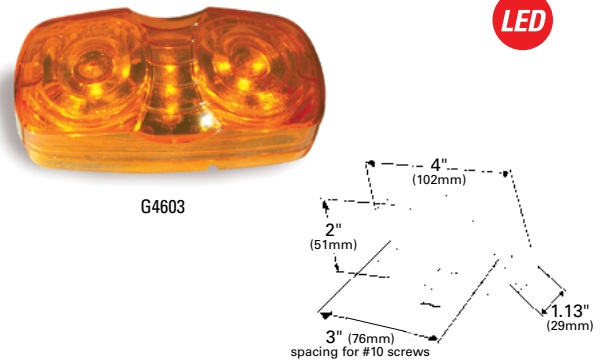

**TWO-BULB SQUARE-CORNER CLEARANCE/MARKER LAMP**

Corrosion-resistant contacts • Snap-on lens for easy bulb replacement • Attached blunt cut pigtail • Meets PC function only when mounted at a 45° angle

- DURAMOLD®**
- 46792 Red **PC**
  - 46792-5 Red **PC RETAIL**
  - 46793 Yellow **PC**
  - 46793-5 Yellow **PC RETAIL**

- DIE CAST**
- 46782 Red **PC**
  - 46783 Yellow **PC**

**Materials:** Duramold: Lens - Polycarbonate; Housing - Polypropylene  
 Die-cast: Lens - Acrylic; Housing - Steel  
**Regulations / Standards:** FMVSS 108 / SAE P2, P3, PC  
**Finish:** Red / Yellow  
**Volts / Amps:** Bulb (2) #1893, 2 CP: 12V / .66A  
**Bracket:** 43144, 43673  
**Pigtail:** 67120  
**Lens:** Red 91962, Yellow 91963, Auxiliary - Clear 91961, Green 91964  
**VMRS Code:** 034-004-021

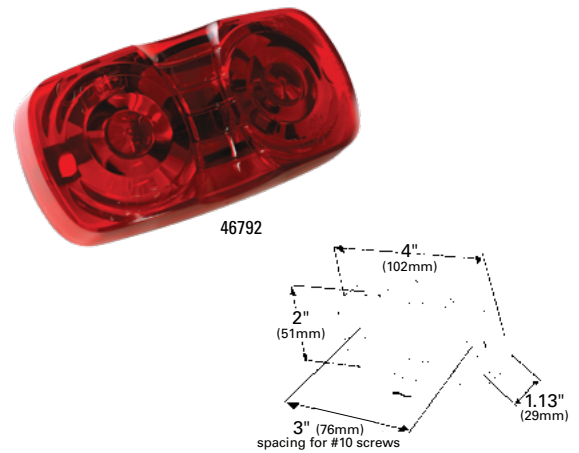

LED

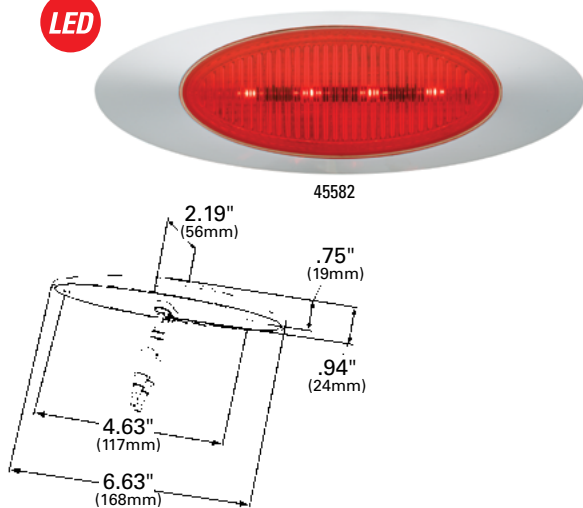
**M1 SERIES LED CLEARANCE/MARKER LAMP**

Sleek, aerodynamic styling • Corrosion-resistant, chrome-plated bezels  
 • Molded bullet kits come with two replacement mating connectors

**LAMP KITS WITH BEZEL:**

<b>45582</b>	Red, .180 Molded Bullet
<b>45583</b>	Yellow, .180 Molded Bullet
<b>47772</b>	Red, Clear Lens, .180 Molded Bullet
<b>47773</b>	Yellow, Clear Lens, .180 Molded Bullet
<b>45603</b>	Yellow, Metri-pack® Plug

**LAMP KITS WITHOUT BEZEL:**

<b>45623</b>	Yellow, .180 Molded Bullet
<b>45643</b>	Yellow, Metri-pack® Plug

**Material:** Lens - Polycarbonate; Housing - Polycarbonate; Bezel - ABS

**Regulations / Standards:** FMVSS 108 / SAE P2

**Finish:** Chrome / Red / Yellow

**Volts / Amps:** 12V / .12A

**Accessory:** Bezel Chrome 93453

**Pigtail:** 66200

**VMRS Code:** 034-004-253

LED

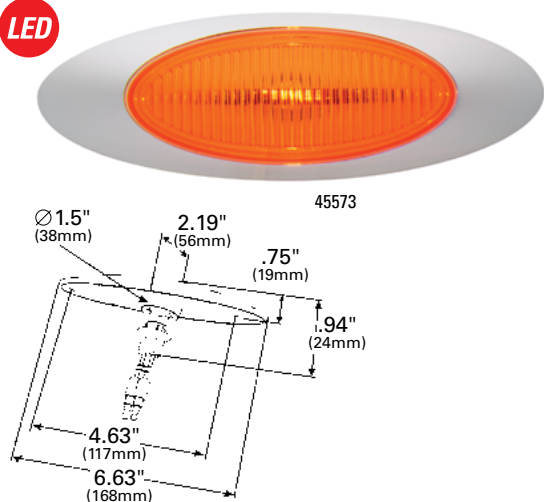
**M1 SERIES CLEARANCE/MARKER LAMP**

Sleek, aerodynamic styling • Molded bullet versions are bulb replaceable  
 • Corrosion-resistant, chrome-plated bezels • Metri-pack® versions have a hermetic lens-to-housing seal

**LAMP KITS WITH BEZEL:**

<b>45573</b>	Yellow, .180 Molded Bullet
<b>45593</b>	Yellow, Metri-pack® Plug

**LAMP KITS WITHOUT BEZEL:**

<b>45633</b>	Yellow, Metri-pack® Plug
--------------	--------------------------

**Material:** Lens and Housing - Polycarbonate; Bezel - Chrome-plated ABS

**Regulations / Standards:** FMVSS 108 / SAE P2

**Finish:** Chrome / Red / Yellow

**Volts / Amps:** Bulb: #193, 2 CP: 12V / .33A; Bulb: #464, 3 CP: 24V / .17A

**Accessory:** Bezel Chrome 93453

**Pigtail:** 66200

**VMRS Code:** 034-004-253

LED

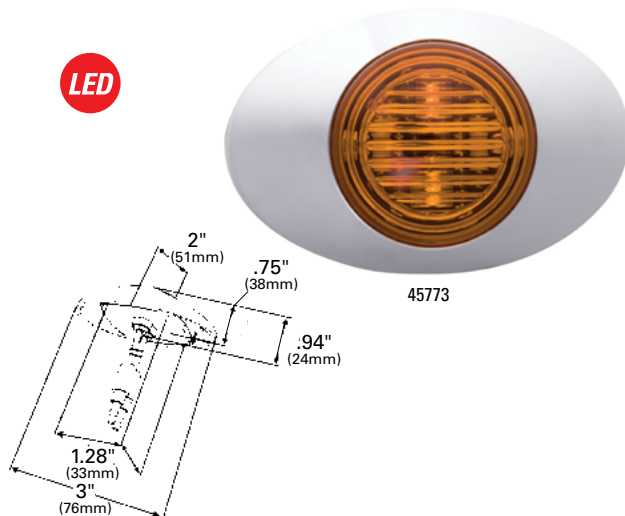
**M3 SERIES LED CLEARANCE/MARKER LAMP**

Sleek, aerodynamic styling • Corrosion-resistant, chrome-plated bezels  
 • Kits contain two replacement mating connectors

**LAMP KITS WITH BEZEL:**

<b>45773</b>	Yellow, .180 Molded Bullet
--------------	----------------------------

**LAMP KITS WITHOUT BEZEL:**

<b>45793</b>	Yellow, .180 Molded Bullet
--------------	----------------------------

**Material:** Lens and Housing - Polycarbonate; Bezel - Chrome-plated ABS

**Regulations / Standards:** FMVSS 108 / SAE P2

**Finish:** Yellow

**Volts / Amps:** 12V / .06A

**Pigtail:** 66200

**VMRS Code:** 034-004-253

### M3 SERIES CLEARANCE/MARKER LAMP

Sleek, aerodynamic styling • Field replaceable, bulb design • Corrosion-resistant, chrome-plated bezels • No exposed fasteners

**45763** Yellow, .180 Molded Bullet

**Material:** Lens and Housing - Polycarbonate; Bezel - Chrome-plated ABS

**Regulations / Standards:** FMVSS 108 / SAE P2

**Finish:** Yellow

**Bulb:** #193, 2 CP

**Volts / Amps:** 12V / .33A

**Pigtail:** 66200

**VMRS Code:** 034-004-253

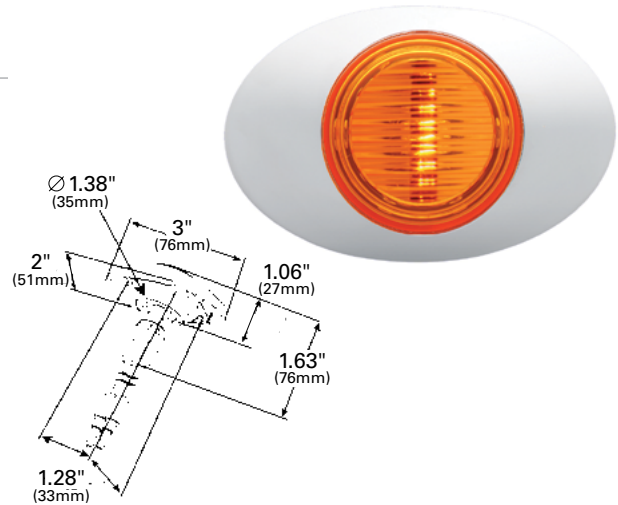

### M5 SERIES LED CLEARANCE/MARKER LAMP

Sleek, aerodynamic styling • Corrosion-resistant chrome-plated bezels • Kits contain two replacement mating connectors • Small size fits into narrow applications

**LAMP KITS WITH BEZEL:**

**47913** Yellow, .180 Molded Bullet

**47922** Red, Clear Lens, .180 Molded Bullet

**47923** Yellow, Clear Lens, .180 Molded Bullet

**Material:** Lens and Housing - Polycarbonate; Bezel - Chrome-plated ABS

**Regulations / Standards:** FMVSS 108 / SAE P2

**Finish:** Chrome / Clear / Red / Yellow

**Pigtail:** 66200

**VMRS Code:** 034-004-253

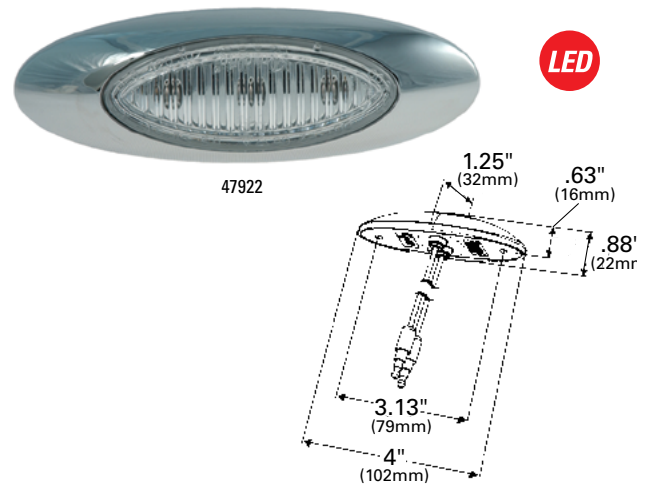

### SUPERNOVA® LOW-PROFILE LED CLEARANCE/MARKER LAMP

Sealed hardwire terminations with .180 molded, UBS Slim-Line bullets • Field replaceable lens • Requires 1 1/4" hole for mounting • Popular marker lamp on Peterbilt® trucks • Built-in reflector

**WITHOUT BEZEL:**

**47262** Red, w/ .180 Molded Bullets

**47263** Yellow, w/ .180 Molded Bullets

**WITH BEZEL:**

**47252** Red, w/ .180 Molded Bullets

**47253** Yellow, w/ .180 Molded Bullets

**Material:** Lens - Acrylic; Housing - Polypropylene; Bezel - Stainless Steel

**Regulations / Standards:** FMVSS 108 / SAE A, P2

**Finish:** Stainless Steel / Red / Yellow

**Volts / Amps:** 12V / .06A

**Lens:** Red 90072, Yellow 90073

**VMRS Code:** 034-004-253





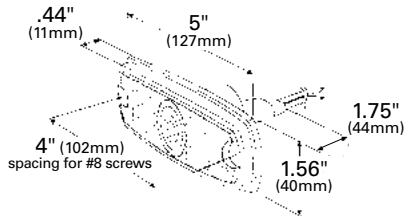

### LOW-PROFILE CLEARANCE/MARKER LAMP

Field-replaceable lens • Requires 1 1/4" socket hole for mounting  
 • Twist-in bulb socket for easy bulb replacement • Built-in reflector

#### WITHOUT BEZEL:

45712 Red  
 45713 Yellow

#### WITH BEZEL:

45662 Red  
 45663 Yellow

**Material:** Lens - Acrylic; Housing - Polypropylene; Bezel - Stainless Steel

**Regulations / Standards:** FMVSS 108 / SAE A, P2

**Finish:** Stainless Steel / Red / Yellow

**Bulb:** #194, 2 CP

**Volts / Amps:** 12V / .27A

**Pigtail:** 68380

**Lens:** Red 90072, Yellow 90073

**VMRS Code:** 034-004-021

LED

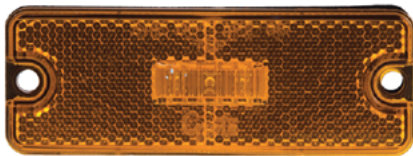

47733

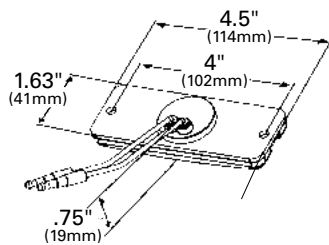

### SEALED RECTANGULAR LED CLEARANCE/MARKER LAMP

Fits standard mounting holes, no bracket required • Uses same .180 molded bullet connections as incandescent versions for a quick, easy retrofit • Replaces Truck-Lite® 18050R (red) or 18050Y (yellow)

47732 Red, w/ .180 Molded Bullets  
 47733 Yellow, w/ .180 Molded Bullets



**Material:** Acrylic

**Regulations / Standards:** FMVSS 108 / SAE A, P2

**Finish:** Red / Yellow

**Volts / Amps:** 12V / .06A, 24V / .06A

**VMRS Code:** 034-004-253

**SUPERNOVA® SEALED TURTLEBACK® II LED CLEARANCE/MARKER LAMP**

Tin-plated, solid-brass terminals are sealed to housing to resist corrosion and eliminate failure causing leak paths • Meets PC function only when mounted at a 45° angle • Not designed for vertical mount

**BUILT-IN REFLECTOR:**

- 47072 Red, Male Pin
- 47073 Yellow, Male Pin

**PC RATED OPTIC LENS:**

- 47162 Red, Male Pin **PC**
- 47163 Yellow, Male Pin **PC**
- 49392 Red, Hardwire **PC**
- 49393 Yellow, Hardwire **PC**

**ABS LAMP:**

- 78403 Yellow, Reflex Lens, Male Pin

**Material:** Reflex - Lens: Acrylic; Housing: Polycarbonate  
 Optic - Lens: Polycarbonate  
 Duel - Housing: Polycarbonate

**Regulations / Standards:** FMVSS 108 / Optic - SAE P2, PC; Reflex - SAE A, P2

**Finish:** Red / Yellow

**Volts / Amps:** P2 - 12V / .06A  
 PC Red - 12V / .04A, Yellow - 12V / .06A

**Bracket:** 43050

**Pigtail:** 66911, 66910, 67070, 67071

**VMRS Code:** 034-004-253

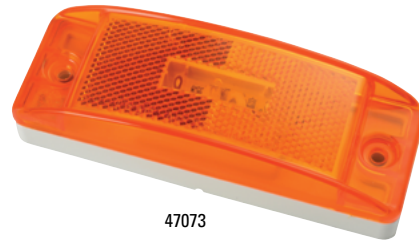

**LED**

47073

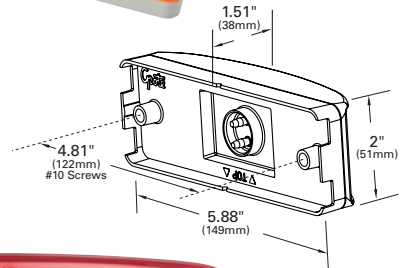

47162

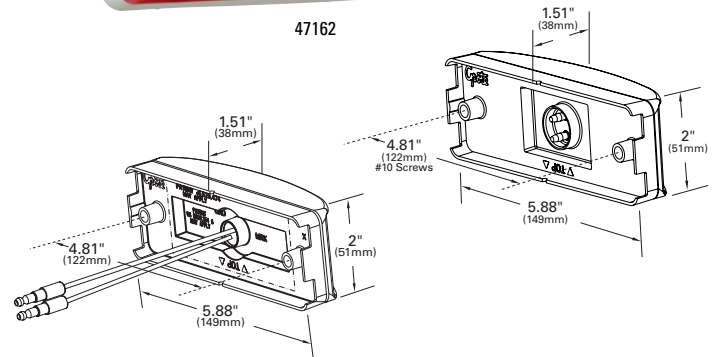

**HI COUNT® TURTLEBACK® II LED CLEARANCE/MARKER LAMP**

Hermetic lens-to-housing seal • Shock-absorbing, heat-resistant lens and lamp base • Red lamp has 8 diodes, yellow lamp has 10 diodes • Built in reflector

- G2102 Red
- G2103 Yellow

**Material:** Lens: Acrylic; Housing: Polycarbonate

**Regulations / Standards:** FMVSS 108 / SAE A, P2

**Finish:** Red / Yellow

**Volts / Amps:** Red - 12V / .12A  
 Yellow - 12V / .15A

**Bracket:** 43050

**VMRS Code:** 034-004-253

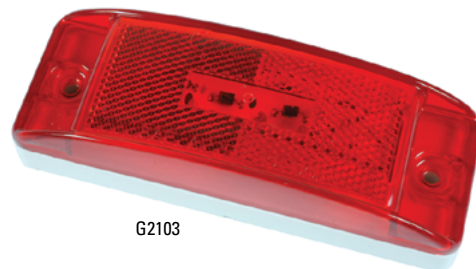

**LED**

G2103

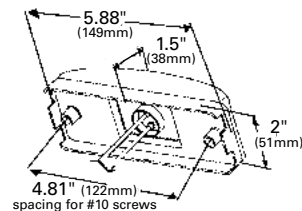

LED

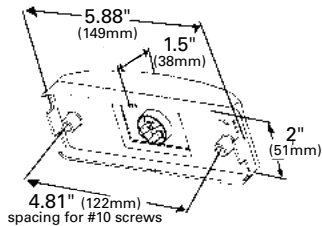

### SUPERNOVA® SEALED TURTLEBACK® II LED DUAL INTENSITY CLEARANCE/MARKER LAMP

Tin-plated, solid-brass terminals are sealed to housing to resist corrosion and eliminate failure-causing leak paths • Meets PC function when mounted at a 45° angle • Not designed for vertical mount

**54003** Yellow, Male Pin

**Material:** Polycarbonate  
**Regulations / Standards:** FMVSS 108 / SAE P2, PC  
**Color:** Yellow  
**Voltage Amp:** 12V / .12A  
**Bracket:** 43050  
**Pigtail:** 66815, 66816, 66841, 66845, 67002, 67005  
**VMRS Code:** 034-004-253

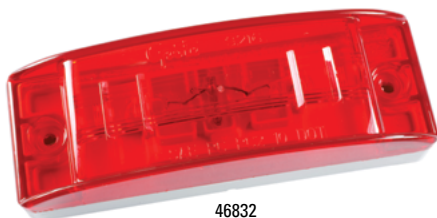

46832



46873

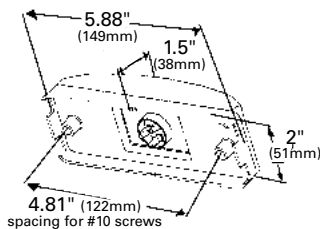

### SEALED TURTLEBACK® II CLEARANCE/MARKER LAMP

Shock-absorbing, heat-resistant lens and lamp base • Waterproof male pin connections accept UBS pigtail • Turtleback® lens design for maximum durability • Optic lens version meets PC function only when mounted at a 45° angle

#### OPTIC LENS:

**46832** Red, Male Pin **PC**  
**46833** Yellow, Male Pin **PC**

#### REFLEX LENS:

**46872** Red, Male Pin  
**46873** Yellow, Male Pin

#### ABS LAMP:

**78363** Yellow, Optic Lens, Male Pin **PC**

**Material:** Reflex: Lens - Acrylic; Housing - Polycarbonate  
 Optic: Lens and Housing - Polycarbonate  
**Regulations / Standards:** FMVSS 108 / Optic - SAE P2, P3, PC;  
 Reflex - SAE A, P2

**Finish:** Red / Yellow  
**Bulb:** (2) 2 CP  
**Volts / Amps:** 12V / .66A  
**Bracket:** 43050  
**Pigtail:** 66910, 66911, 67070, 67071  
**VMRS Code:** 034-004-021

**ECONOMY SEALED CLEARANCE/MARKER LAMP**

Self grounding eyelet grounds lamp when attached to a metal plate  
 • Retrofits to competitor lamps easily with hot wire termination; Truck-Lite® 21201R (red) or 21201Y (yellow) • Reflex built-in

- 46072 Red
- 46073 Yellow

**KITS:**

- 46082 Red (46072 + 66360)
- 46083 Yellow (46073 + 66360)

**Material:** Acrylic  
**Regulations / Standards:** FMVSS 108 / SAE A, P2  
**Finish:** Red / Yellow  
**Bulb:** 2 CP  
**Volts / Amps:** 12V / .33A  
**Pigtail:** 66360  
**VMRS Code:** 034-004-021

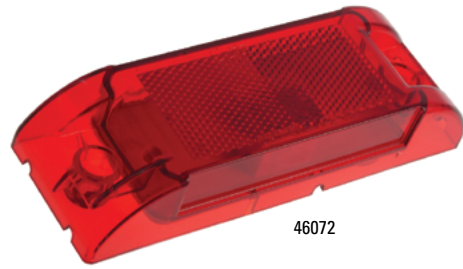

46072

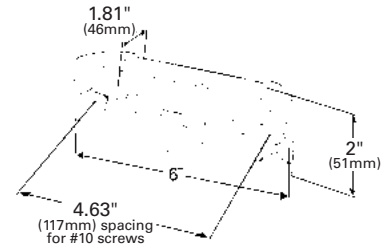

**TWO-BULB TURTLEBACK® CLEARANCE/MARKER LAMP**

Two stainless steel grounds

**OPTIC LENS:**

- 45462 Red
- 45463 Yellow

**BUILT-IN REFLECTOR:**

- 46302 Red
- 46303 Yellow

**Material:** Optic: Lens - Polycarbonate; Housing - Polypropylene  
 Reflex: Lens - Acrylic; Housing - Polypropylene  
**Regulations / Standards:** FMVSS 108 / Optic - SAE P2; Reflex - SAE A, P2  
**Finish:** Red / Yellow  
**Bulb:** (2) #1893, 2 CP  
**Volts / Amps:** 12V / .66A  
**Pigtail:** 67120  
**Lens:** Optic - Red 90172, Yellow 90173; Reflex - Red 91042, Yellow 91043  
**VMRS Code:** 034-004-021

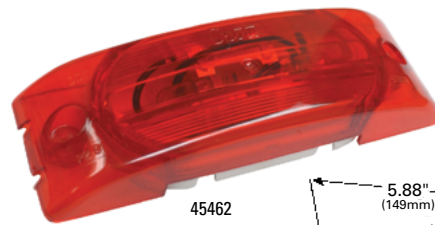

45462

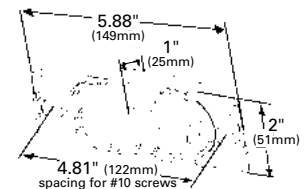

46303



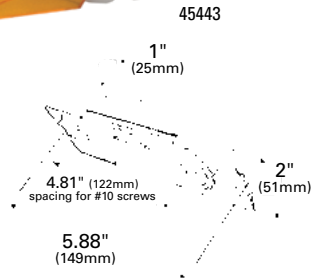
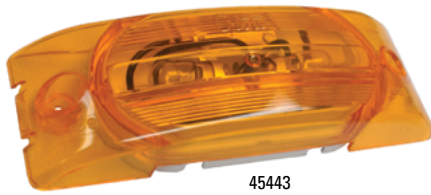

### TWO-BULB TURTLEBACK® NO-SPLICE CLEARANCE/MARKER LAMP

No-splice wiring system • Turtleback® lens design for maximum durability  
• Corrosion-resistant contacts

45442 Red  
45443 Yellow

**Material:** Lens - Polycarbonate; Housing - Polypropylene

**Regulations / Standards:** FMVSS 108 / SAE P2

**Finish:** Red / Yellow

**Bulb:** (2) #1893, 2 CP

**Volts / Amps:** 12V / .66A

**Lens:** Red 90172, Yellow 90173

**VMRS Code:** 034-004-021

LED

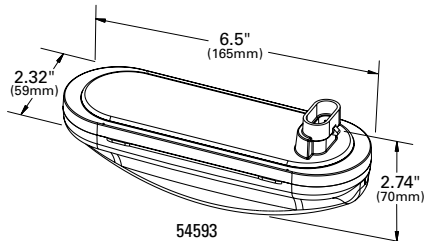

### RAZORBACK MID-POSITION FLASHING LED MARKER LAMP

Patent-pending electronic design meets all FMVSS 108 marker requirements and also flashes in concert with the turn signal circuitry to act as a mid-position flasher • 50-State-Legal flashing mid-position marker • Easily visible from the cab during operation • Fits current mounting flanges and grommets

54593 Yellow, Hardshell  
54663 Yellow, Male Pin

**Material:** Polycarbonate

**Finish:** Yellow

**Regulations / Standards:** FMVSS 108 / SAE P2

**Volts / Amps:** 13.5V / .18A

**Brackets:** 43220, 43222, 43223, 43732, 43362, 43952, 43172, 43100, 42152, 42153

**Grommet:** 92420, 92720

**Pigtails:** 66861

**VMRS Code:** 034-003-097

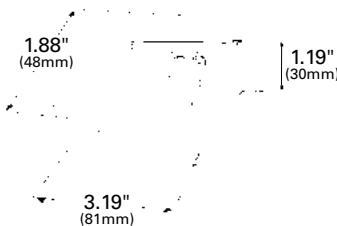

### SMALL SQUARE PC-RATED CLEARANCE/MARKER LAMP

Direct replacement for Truck-Lite® 12200R • Includes gasket • Sonic sealed lens

46092 Red **PC**

**Material:** Polycarbonate

**Regulations / Standards:** FMVSS 108 / SAE P2, PC

**Finish:** Red

**Bulb:** 2 CP

**Volts / Amps:** 12V / .33A

**VMRS Code:** 034-004-021

## DIE-CAST ALUMINUM CLEARANCE/MARKER LAMP

Mounts without disassembly • Holes interchange with competitive lamps for easy retrofits • Lens replaces comparable competitor models • Meets PC function only when mounted at a 45° angle

**FLAT BACK, NO SOCKET HOLE REQUIRED:**

- 46282 Red **PC**
- 46283 Yellow **PC**

**Material:** Lens - Acrylic; Housing - Aluminum  
**Regulations / Standards:** FMVSS 108 / SAE P2, PC  
**Finish:** Red / Yellow  
**Bulb:** #193, 2 CP  
**Volts / Amps:** 12V / .33A  
**Lens:** Red 90922, Yellow 90923  
**VMRS Code:** 034-004-021

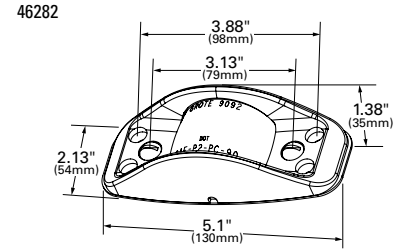

## NARROW-RAIL CLEARANCE/MARKER LAMP

Steel housing for additional lamp protection • Two- or four-hole mounting for easy retrofits • Flat back; no need for lamp socket hole • Meets PC function only when mounted at a 45° angle

- 45172 Red **PC**
- 45173 Yellow **PC**

**Material:** Lens - Acrylic; Housing - Steel  
**Regulations / Standards:** FMVSS 108 / SAE P2, P3, PC  
**Finish:** Red / Yellow  
**Bulb:** #193, 2 CP  
**Volts / Amps:** 12V / .33A  
**Lens:** Red 90052, Yellow 90053, Auxiliary: Clear 90051  
**VMRS Code:** 034-004-021

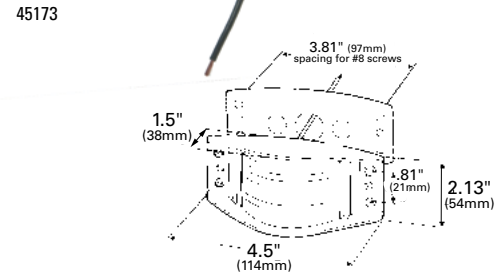

## ARMORED CLEARANCE/MARKER LAMP

Steel housing for additional lamp protection • Two- or four-hole mounting for easy retrofits • Rear socket hole required • Meets PC function only when mounted at a 45° angle

- 45012 Red **PC**
- 45013 Yellow **PC**

**Material:** Lens - Acrylic; Housing - Steel  
**Regulations / Standards:** FMVSS 108 / SAE P2, P3, PC  
**Finish:** Red / Yellow  
**Bulb:** #67, 4 CP  
**Volts / Amps:** 12V / .59A  
**Pigtail:** 68080  
**Lens:** Red 90052, Yellow 90053; Auxiliary: Clear 90051  
**VMRS Code:** 034-004-021

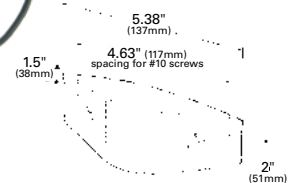
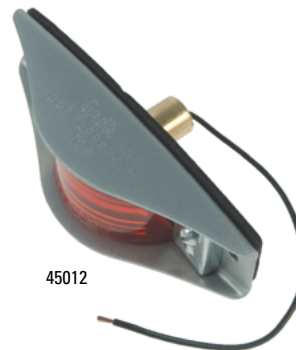

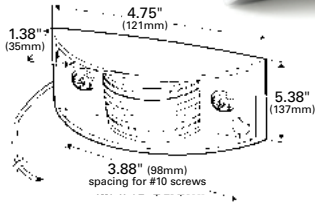

46893

**CHROME-ARMORED CLEARANCE/MARKER LAMP**

Direct interchange for competitive models • Flat back; no bulb socket hole required • Meets PC function only when mounted at a 45° angle

46892	Red	PC
46892-5	Red	PC RETAIL
46893	Yellow	PC
46893-5	Yellow	PC RETAIL

**Material:** Lens - Acrylic; Housing - Chrome-plated ABS

**Regulations / Standards:** FMVSS 108 / SAE P2, PC

**Finish:** Red / Yellow

**Bulb:** #194, 2 CP

**Volts / Amps:** 12V / .27A

**Lens:** Red 90922, Yellow 90923

**VMRS Code:** 034-004-021

LED

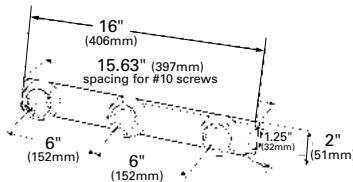
**SUPERNOVA® LOW-PROFILE LED BAR LAMP**

Twist-in, locking feature • Sealed UBS harness • Uses 2 1/2" round LED replacement lamps

49162 Red

**Material:** Lens - Polycarbonate; Housing - Steel

**Regulations / Standards:** FMVSS 108 / SAE P2

**Finish:** Red

**Volts / Amps:** 12V / .18A

**Accessory:** Lamp: Red 47122; Harness: 67740

**VMRS Code:** 034-004-149

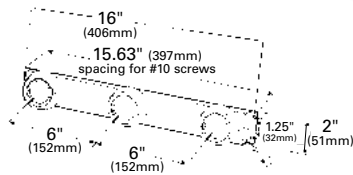
**LOW-PROFILE BAR LAMP**

Uses 2 1/2" round, replaceable lamps • Twist-in, locking feature • Sealed UBS harness

49142 Red

**Material:** Lens - Polycarbonate; Housing - Steel

**Regulations / Standards:** FMVSS 108 / SAE P2

**Finish:** Red

**Bulb:** (3) 2 CP

**Volts / Amps:** 12V / .99A

**Accessory:** Harness: 67740, Lamp: Red 45812

**VMRS Code:** 034-004-149

LED

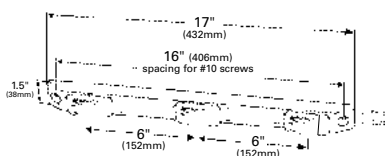
**SUPERNOVA® LED BAR LAMP**

Snap-on replacement lamps • Sealed flow-through UBS harness • Rugged reinforced polycarbonate bar • Easy to install

49182 Red

**Material:** Polycarbonate

**Regulations / Standards:** FMVSS 108 / SAE P2

**Finish:** Red

**Volts / Amps:** 12V / .18A

**Accessory:** Lamp: Red 47082; Harness: 69710

**VMRS Code:** 034-004-149

### POLYCARBONATE BASE BAR LAMP

Three replaceable snap-on lamps • Sealed flow-through harness  
 • Rugged reinforced polycarbonate bar • Easy to install

**49172** Red

**Material:** Polycarbonate  
**Regulations / Standards:** FMVSS 108 / SAE P2  
**Finish:** Red  
**Bulb:** (3) 2 CP  
**Volts / Amps:** 12V / .99A  
**Accessory:** Lamp: Red 46412, Yellow 46413; Harness: 69710  
**VMRS Code:** 034-004-149

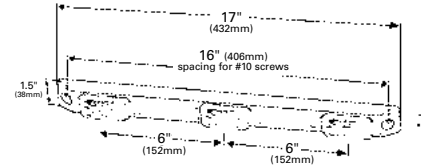

### ALUMINUM BASE BAR LAMP

Thin-line design fits narrow rails and channels • Three two-bulb replaceable snap-on lamps • Easy installation • UBS wire harness included

**49132** Red

**Material:** Lens - Polycarbonate; Housing - Aluminum  
**Regulations / Standards:** FMVSS 108 / SAE P2  
**Finish:** Red  
**Bulb:** (6) 2 CP  
**Volts / Amps:** 12V / 1.98A  
**Accessory:** Lamp: Red 46742  
**VMRS Code:** 034-004-149

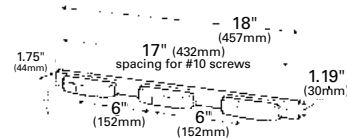

### MICRONOVA® LED BAR LAMP

Low-profile design fits narrow rail applications • Easy to install  
 • Rugged reinforced polycarbonate bar

**49202** Red

**Material:** Polycarbonate  
**Regulations / Standards:** FMVSS 108 / SAE P2  
**Finish:** Red  
**Volts / Amps:** 12V / .16A  
**Accessory:** Lamps: Red 47962  
**VMRS Code:** 034-004-149

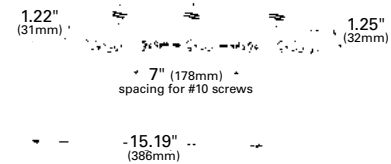

### SUPERNOVA® THIN-LINE LED BAR LAMP

Thin-Line design fits narrow rails and channels • Easy installation  
 • Sealed UBS harness included • Replaceable external guard made of formed aluminum

**49122** Red

**Material:** Lens - Polycarbonate; Housing - Aluminum  
**Regulations / Standards:** FMVSS 108 / SAE P2  
**Finish:** Red  
**Volts / Amps:** 12V / .18A  
**Branch Guard:** 43074  
**VMRS Code:** 034-004-149

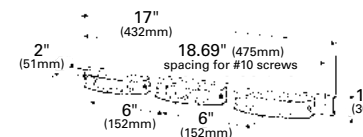



LED

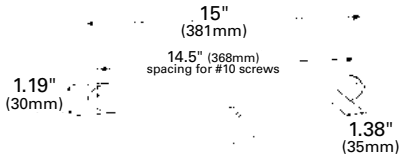

49192

**15" SLIM LED BAR LAMP**

Impact-resistant housing is sealed for moisture protection

**49192** Red  
**49223** Yellow  
**49242-5** Red, 13.5" **RETAIL**

**Material:** Polycarbonate  
**Regulations / Standards:** FMVSS 108 / SAE P2, P3  
**Finish:** Red / Yellow  
**Volts / Amps:** 12V / .25A  
**VMRS Code:** 034-004-149

LED

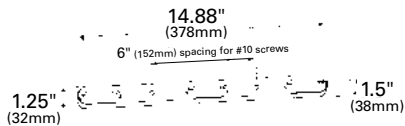
**2 1/2" OVAL LED BAR LAMP**

Impact resistant housing with sonic sealed, shock and vibration-resistant lamps • Uses three dual-diode LED lamps

**49212-5** Red **RETAIL**

**Material:** Lens and Housing - Polycarbonate; Bar - ABS  
**Regulations / Standards:** FMVSS 108 / SAE P2  
**Finish:** Red  
**Volts / Amps:** 12V / .15A  
**Accessory:** Lamp: Red 47012  
**VMRS Code:** 034-004-149

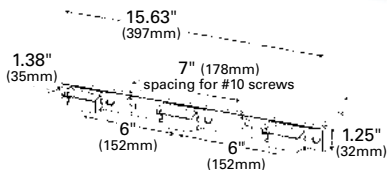
**ECONOMY BAR LAMP**

Three bulb-replaceable 46882 lamps • Formed steel bar with white enamel

**49112** Red  
**49112-5** Red **RETAIL**

**Material:** Lens - Acrylic; Housing - Polycarbonate; Bar - Formed Steel  
**Regulations / Standards:** FMVSS 108 / SAE P2  
**Finish:** Red  
**Bulb:** (3) #194, 2 CP  
**Volts / Amps:** 12V / .81A  
**Lens:** Red 92432  
**VMRS Code:** 034-004-149

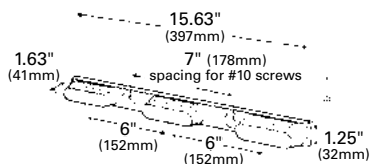
**THIN-LINE BAR LAMP**

Three bulb-replaceable 45252 lamps • Black powder-coated, formed steel bar

**49062** Red

**Material:** Lens - Acrylic; Housing - Polycarbonate; Bar - Formed Steel  
**Regulations / Standards:** FMVSS 108 / SAE P2  
**Finish:** Red  
**Bulb:** (3) #193, 2 CP  
**Volts / Amps:** 12V / .99A  
**Replacement Lens:** Red 90152  
**VMRS Code:** 034-004-149

## LOW-PROFILE BAR LAMP

Three-bulb, replaceable 45262 or 46792 lamps

- 49072 Red, Oval Style
- 49082 Red, Square Corner Style

**Material:** Lens and Housing - Polycarbonate; Housing and Bar - Polypropylene  
**Regulations / Standards:** FMVSS 108 / SAE P2  
**Finish:** Red  
**Bulb:** (6) #1893, 2 CP  
**Volts / Amps:** 12V / 1.98A  
**Lens:** Oval - 90122; Square - 91962  
**VMRS Code:** 034-004-149



49082

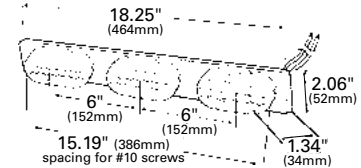

## OEM-STYLE, LARGE AERODYNAMIC CAB MARKER LAMP

3/8" thick mounting gasket • Mounting holes interchange with most popular torpedo-type cab marker lamps • Chrome-plated body, long-life bulb • Used on Ford®, Navistar®, and Freightliner® trucks • Meets side marker and front clearance requirements simultaneously

- 46823 Yellow **PC**

**Material:** Lens - Polycarbonate; Housing - Chrome-Plated ABS  
**Regulations / Standards:** FMVSS 108 / SAE P2, P3, PC  
**Finish:** Chrome / Yellow  
**Bulb:** #904, 4 CP  
**Volts / Amps:** 12V / .69A  
**Lens:** Yellow 92193  
**VMRS Code:** 034-004-021

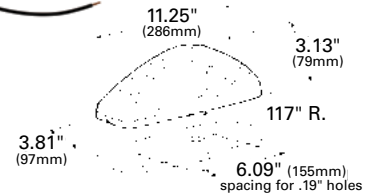

## SUPERNOVA® SMALL AERODYNAMIC LED CAB MARKER LAMP

Meets side marker and front clearance requirements simultaneously

- 47183 Yellow **PC**

**Material:** Lens - Polycarbonate; Housing - Valox®  
**Regulations / Standards:** FMVSS 108 / SAE P2, PC  
**Finish:** Yellow  
**Volts / Amps:** 12V / .12A  
**Accessory:** Chrome Bezel: 92583  
**Lens:** Yellow 92183  
**VMRS Code:** 034-004-253



**LED**

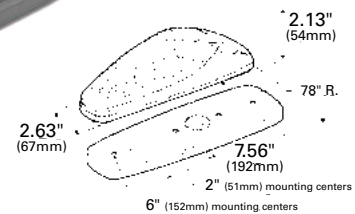

## LOW-PROFILE AERODYNAMIC CAB MARKER LAMP

Aerodynamic design • Cab marker replacement for heavy-duty Ford® trucks • Field-replaceable lens • Mounting screws included

- 46003 Yellow
- 46003-5 Yellow **RETAIL**

**Material:** Polycarbonate  
**Regulations / Standards:** FMVSS 108 / SAE P2, PC  
**Finish:** Yellow  
**Volts / Amps:** Bulb #168, 3 CP: 12V / .27A  
**Lens:** Yellow 93393  
**VMRS Code:** 034-004-021



**LED**

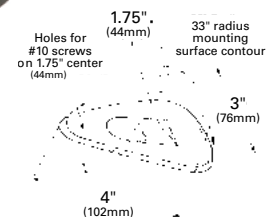

LED

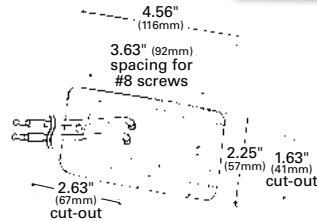
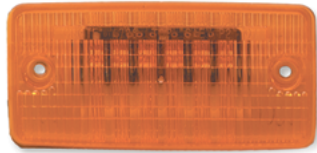

### SUPERNOVA® FLUSH-MOUNT LED CAB MARKER LAMP

Potted for total circuit board protection • Sealed hardwire connections with UBS molded .180 bullet terminals • Freightliner®, Sterling®, and Navistar® replacement

**47063** Yellow

**Material:** Polycarbonate  
**Regulations / Standards:** FMVSS 108 / SAE P2  
**Finish:** Yellow  
**Volts / Amps:** 12V / .12A  
**VMRS Code:** 034-004-253

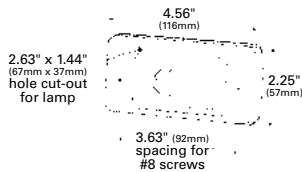

### FLUSH-MOUNT CAB MARKER LAMP

Application for visors • Hermetic lens-to-housing seal • Used on Freightliner®

**46913** Yellow

**Material:** Polycarbonate  
**Regulations / Standards:** FMVSS 108 / SAE P2  
**Finish:** Yellow  
**Pigtail:** 68380  
**VMRS Code:** 034-004-021

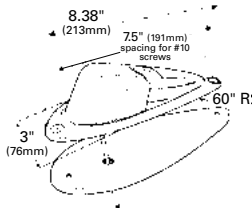

### DELUXE DIE-CAST CAB MARKER LAMP

Easy installation • Neoprene mounting pad • Chrome-plated • Meets side marker and front clearance requirements simultaneously

**45333** Yellow

**Material:** Lens - Acrylic; Housing - Chrome-Plated Zinc Die-cast  
**Regulations / Standards:** FMVSS 108 / SAE P2, P3  
**Finish:** Chrome / Yellow  
**Bulb:** #67, 4 CP  
**Volts / Amps:** 12V / .59A  
**Pigtail:** 68080  
**VMRS Code:** 034-004-021

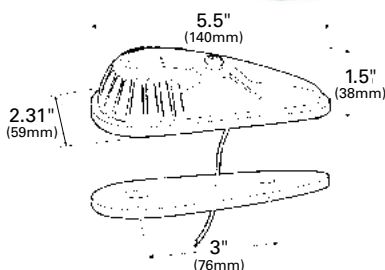

### ECONOMY CAB MARKER LAMP

Fits flat or slight contour surfaces • Replaces original equipment on Ford® trucks • Meets side marker and front clearance requirements simultaneously

**46543** Yellow **PC**  
**46543-5** Yellow **PC RETAIL**

**Material:** Lens - Acrylic; Housing - ABS  
**Regulations / Standards:** FMVSS 108 / SAE P2, PC  
**Finish:** Yellow  
**Bulb:** #67, 4 CP  
**Volts / Amps:** 12V / .59A  
**Pigtail:** 68170  
**Lens:** Yellow 91683  
**VMRS Code:** 034-004-021

### FORD® LIGHT DUTY CAB MARKER LAMP

Replaces surface mount, cab marker on Ford® F-Series trucks • Replaceable bulb design • Mounting pad and screws included

**45503** Yellow **PC**

**Material:** Lens - Polycarbonate; Housing - ABS  
**Regulations / Standards:** FMVSS 108 / SAE P2, PC  
**Finish:** Yellow  
**Bulb:** #194, 2 CP  
**Volts / Amps:** 12V / .27A  
**VMRS Code:** 034-004-021

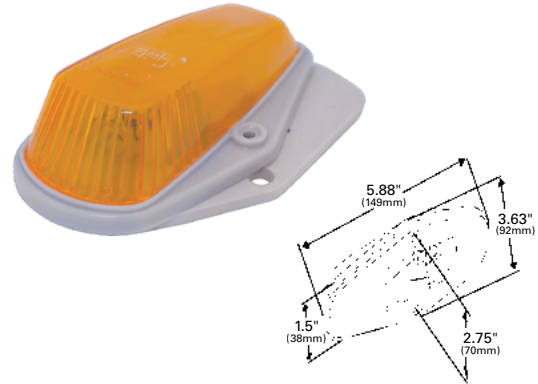

### SHOCK-RESISTANT TORPEDO-STYLE CAB MARKER LAMP

Replacement for Mack® and Kenworth® • Includes two 1/4" bolts on 9 3/4" centers for mounting

**45993** Yellow **PC**

**Material:** Lens - Acrylic; Housing - Chrome-Plated ABS  
**Regulations / Standards:** FMVSS 108 / SAE P2, PC  
**Finish:** Yellow  
**Bulb:** #67, 4 CP  
**Volts / Amps:** 12V / .59A  
**Lens:** Yellow 92773  
**VMRS Code:** 034-004-021

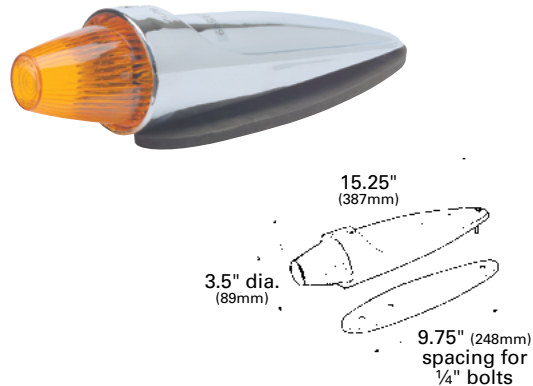

### HI COUNT® SCHOOL BUS WEDGE LED MARKER LAMP

Potted circuit board • Mounting gasket included • Blunt cut, hardwire termination • 15 diodes in both red and yellow lamps • Meets PC when mounted at a 45° only

**G5052** Red **PC**  
**G5053** Yellow **PC**  
**G5053-5** Yellow **PC RETAIL**

**Material:** Polycarbonate  
**Regulations / Standards:** FMVSS 108 / SAE P2, PC  
**Finish:** Red / Yellow  
**Volts / Amps:** 12V / .1A  
**VMRS Code:** 034-004-253

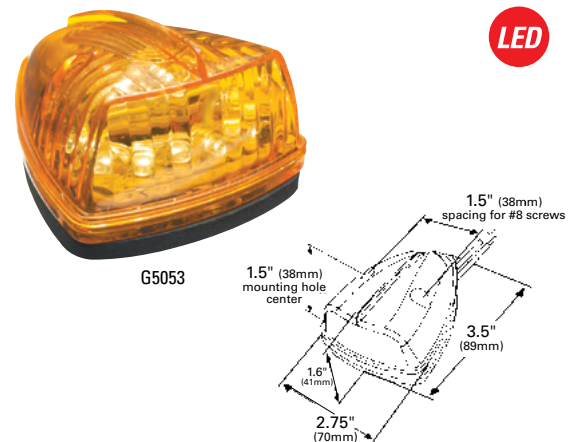



46323

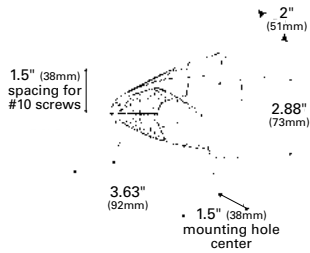

### SCHOOL BUS WEDGE MARKER LAMP

Adaptable front/side/rear mount • Galvanized steel housing  
• Fits most school bus applications

46322 Red  
46323 Yellow

**Material:** Lens - Acrylic; Housing - Galvanized Steel

**Regulations / Standards:** FMVSS 108 / SAE P2

**Finish:** Red / Yellow

**Bulb:** #168, 3 CP

**Volts / Amps:** 12V / .35A

**Lens:** Red 99912, Yellow 99913

**VMRS Code:** 034-004-021



46332

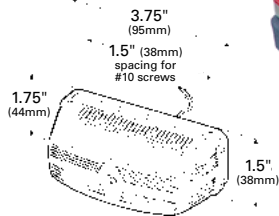

### SCHOOL BUS RECTANGULAR MARKER LAMP

OEM-style • Fits most school bus applications • Includes mounting pad

46332 Red  
46333 Yellow

**Material:** Lens - Acrylic; Housing - Zinc

**Regulations / Standards:** FMVSS 108 / SAE P2

**Bulb:** #168, 3 CP

**Volts / Amps:** 12V / .35A

**Lens:** Red 99802, Yellow 99803

**VMRS Code:** 034-004-021



## FEMALE PIN CLEARANCE MARKER PIGTAILS

For more information on pigtail products see **Pigtails** section: page 254

### SEALED MARKER LAMP PIGTAILS

DOUBLE SEAL:	
<b>67001</b>	6" Long, Ring Terminal Ground, Blunt Cut Wire
<b>66850</b>	6" Long, Chassis Ground
<b>66851</b>	6" Long, Ground Return
SINGLE SEAL:	
<b>66801</b>	6" Long, Ground Return
<b>67050</b>	6" Long, Ring Terminal Ground, Blunt Cut Wire
<b>67050-5</b>	6" Long, Ring Terminal Ground, Blunt Cut Wire <b>RETAIL</b>
<b>66840</b>	6" Long, Chassis Ground, Standard .180 Male
<b>66800</b>	6" Long, Chassis Ground, Slim-Line .180 Male

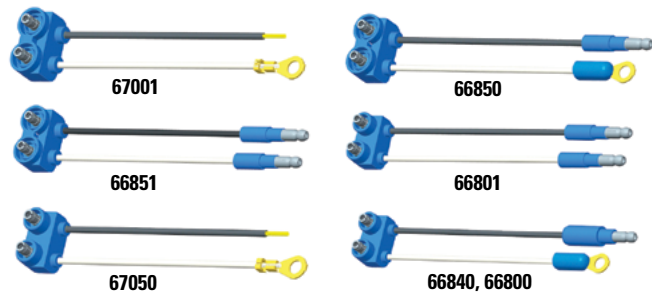

## MALE PIN CLEARANCE MARKER PIGTAILS

### CLEARANCE / MARKER PIGTAILS

<b>66980</b>	6" Long, Chassis Ground, Slim-Line .180 Male
<b>66981</b>	6" Long, Universal Replacement, Blunt Cut, Ring Terminal Grommet
<b>66982</b>	8" Long, Ground Return

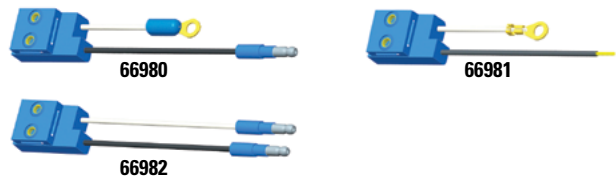

## THIN LINE CLEARANCE MARKER PIGTAILS

### THIN-LINE LED PIGTAILS

<b>66930</b>	5" Long, Chassis Ground System
<b>66931</b>	6" Long, Ground Return



### HIGH-MOUNT STOP LAMP PIGTAIL

<b>66870</b>	12 1/2" Long, Slim-Line .180 Male
--------------	-----------------------------------



### TRIPLE-LAMP ID HARNESSSES

<b>66111</b>	54" Long, Universal Triple-ID Jumper (31"x12"x12")
<b>66932</b>	60" Long, LED Triple-ID Jumper (36"x12"x12")

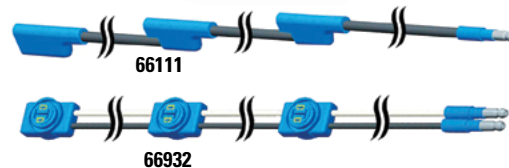

## TURTLEBACK® CLEARANCE MARKER PIGTAILS

For more information on pigtail products see **Pigtails** section: page 254

### SEALED, ECONOMY CLEARANCE/ MARKER LAMP PIGTAIL

66360 6 3/4" Long w/ 3/8" Wire Strip



66360

### TURTLEBACK® II DOUBLE-SEAL LAMP PIGTAILS

66910 6" Long, Chassis Ground, Slim-Line .180 Male

66911 6" Long, Ground Return, Standard .180 Male

67070 2 1/2" Long, Ground Wire, Standard .180 Male

67071 Two-Wire, Standard .180 Male



66910

66911



67070

67071

### SENTRY LAMP PIGTAILS

66900 6" Long, Chassis Ground, Slim-Line .180 Male, 3 1/2" Ground, Star Ring Terminal

66904 6" Long, Ground Return, Slim-Line .180 Male

66905 6" Long, Chassis Ground, Slim-Line .180 Male



66900

66904



66905

### SENTRY HIGH-MOUNT STOP PIGTAIL

66902 6" Long, Slim-Line .180 Male, 3" Ground, Star Ring Terminal



66902

### STOP / TAIL / TURN THREE-WIRE PLUG-IN PIGTAILS FOR MALE PIN LAMPS

66815 6" Long, Ground Return, Slim-Line .180 Male

66841 8" Long, Chassis Ground, Slim-Line .180 Male

67002 11" Long, Chassis Ground, Blunt Cut Wire



66815

66841



67002

### STOP / TAIL / TURN THREE-WIRE 90° PLUG-IN PIGTAILS FOR MALE PIN LAMPS

66816 6" Long, Ground Return System, 90° Plug, Slim-Line .180 Male

66845 8" Long, Chassis Ground, 90° Plug, Slim-Line .180 Male

67005 11" Long, Chassis Ground, 90° Plug, Blunt Cut Wires



66816

66845



67005

## MICRONOVA® DOT MOUNTING

For more information on mounting products see **Mounting Options** section: page 264



### HOODED MICRONOVA® DOT GROMMET

94360 Black

Material: PVC  
Finish: Black



### MICRONOVA® DOT ROUND ADAPTER BRACKETS

- 42302 2" Round Grommet Adapter
- 42312 2.5" Round Grommet Adapter
- 42292 3" Round Flange Adapter
- 42282 3.5" Round Flange Adapter



### MICRONOVA® SECURITY PLATE

42063 Stainless Steel

Material: Stainless Steel  
Finish: Stainless Steel



### SURFACE MOUNT BRACKET FOR MICRONOVA® OR MICRONOVA DOT

- 42110 Gray
- 42120 Gray, Corner Radius Bracket

Material: Polycarbonate  
Finish: Gray



### MICRONOVA® SURFACE MOUNT BRACKET

42070 Gray

Material: Polycarbonate  
Finish: Gray



### MICRONOVA® DOT ADAPTER BRACKET

94350 Gray

Material: Polycarbonate  
Finish: Gray

## MICRONOVA® MOUNTING



### MICRONOVA® OVAL BEZEL

42343 Stainless Steel Bezel

Material: Stainless Steel  
Finish: Stainless Steel



### MICRONOVA® LAMP BEZEL

93803 Chrome-Plated

Material: ABS  
Finish: Chrome

## 2" CLEARANCE MARKER MOUNTING

For more information on mounting products see **Mounting Options** section: page 264



### RECESSED MOUNTING GROMMET FOR 2" ROUND LAMPS

- 92120 Open Grommet  
92150 Closed Back Grommet

#### KITS:

- 94100 Open Grommet (92120 + 67050)

**Material:** PVC  
**Finish:** Black



### TWIST-IN SURFACE MOUNT BRACKET FOR 2" AND 2½" ROUND LAMPS

- 43690 Gray

**Material:** Polycarbonate  
**Finish:** Gray



### THEFT-RESISTANT MOUNTING FLANGE FOR 2" ROUND LAMPS

- 43150 Gray, Polycarbonate  
43152 Black, Polycarbonate  
43153 Chrome-Plated, ABS

**Material:** Polycarbonate/ABS  
**Finish:** Gray/Black/Chrome



### TWIST-IN SURFACE MOUNT BRACKET FOR 2" AND 2½" ROUND LAMPS

- 42180 Gray

**Material:** Polycarbonate  
**Finish:** Gray

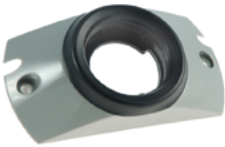

### SURFACE MOUNT BRACKET WITH GROMMET FOR 2" ROUND LAMPS

- 93760 Gray

**Material:** Polycarbonate  
**Finish:** Gray  
**Grommet:** 92120

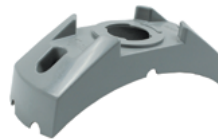

### 4 5/8" CORNER RADIUS SURFACE MOUNT BRACKET FOR 2" AND 2½" ROUND LAMPS

- 43760 Gray

**Material:** Polycarbonate  
**Finish:** Gray



### LICENSE LAMP MOUNTING BRACKET

- 43040 White

**Material:** Polycarbonate  
**Finish:** White



### 90° ANGLE MOUNTING BRACKET FOR 2" AND 2½" ROUND LAMPS

- 43532 Accommodates 94100, 92120, and 92150 Grommets (2 5/16" Hole)

**Material:** Steel  
**Finish:** Black Enamel

## 2 1/2" CLEARANCE MARKER MOUNTING

For more information on mounting products see **Mounting Options** section: page 264



### RECESSED MOUNTING GROMMET FOR 2 1/2" ROUND LAMPS

- 91400 Open Grommet
- 92070 Closed Back Grommet

**KITS:**

- 94010 Open Grommet (91400 + 67050)

**Material:** PVC  
**Finish:** Black

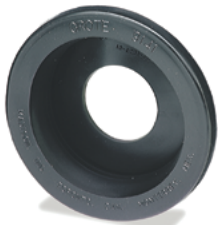

### RECESSED MOUNTING GROMMET FOR 2 1/2" ROUND LAMPS

- 91410 Open Grommet

**KITS:**

- 94000 Open Grommet (91410 + 67050)

**Material:** PVC  
**Finish:** Black

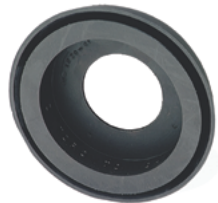

### 45° ANGLED BEVELED-EDGE RECESSED MOUNTING GROMMET FOR 2 1/2" ROUND LAMPS

- 91880 Open Grommet
- 92920 Closed Back Grommet

**Material:** PVC  
**Finish:** Black

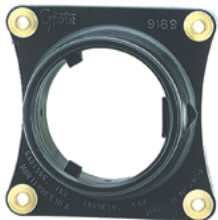

### SURFACE MOUNT GROMMET FOR 2 1/2" ROUND LAMPS

- 91890 Open Grommet

**Material:** PVC  
**Finish:** Black

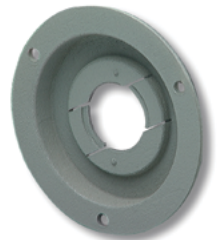

### THEFT-RESISTANT MOUNTING FLANGE FOR 2 1/2" ROUND LAMPS

**MOUNTING FLANGE:**

- 43160 Gray, Polycarbonate
- 43162 Black, Polycarbonate
- 43163 Chrome-Plated, ABS

**PIGTAIL RETENTION CAP:**

- 93670 Gray

**Material:** Polycarbonate/ABS  
**Finish:** Gray/Black/Chrome



### SNAP-IN MOUNTING FLANGE FOR 2 1/2" ROUND LAMPS

**MOUNTING FLANGE:**

- 42170 Gray

**SECURITY RING:**

- 43823 Stainless Steel

**Material:** Polycarbonate/Stainless Steel  
**Finish:** Gray/Chrome

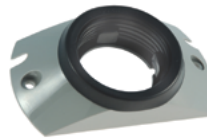

### SURFACE MOUNTING BRACKET WITH GROMMET FOR 2 1/2" ROUND LAMPS

- 93750 Gray

**Material:** Polycarbonate/PVC  
**Finish:** Gray/Black

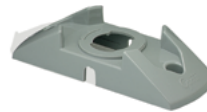

### TWIST-IN SURFACE MOUNT BRACKET FOR 2" AND 2 1/2" ROUND LAMPS

- 43690 Gray

**Material:** Polycarbonate  
**Finish:** Gray



### TWIST-IN SURFACE MOUNT BRACKET FOR 2" AND 2 1/2" ROUND LAMPS

- 42180 Gray

**Material:** Polycarbonate  
**Finish:** Gray

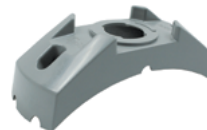

### 4 5/8" CORNER RADIUS SURFACE MOUNT BRACKET FOR 2" AND 2 1/2" ROUND LAMPS

- 43760 Gray

**Material:** Polycarbonate  
**Finish:** Gray



### 90° ANGLE MOUNTING BRACKET FOR 2" AND 2 1/2" ROUND LAMPS

**FOR 2 1/2" LAMPS:**

- 43512 Accommodates 94010, 91400, 92070 Grommets (2 25/32" Hole)
- 43522 Accommodates 94000, 91410 Grommets (3" Hole)

**FOR 2" LAMPS:**

- 43532 Accommodates 94100, 92120, and 92150 Grommets (2 5/16" Hole)

**Material:** Steel  
**Finish:** Black Enamel



## 3" CLEARANCE MARKER MOUNTING

For more information on mounting products see **Mounting Options** section: page 264



### GROMMET FOR SMALL RECTANGULAR LAMPS

91380 Black

**Material:** PVC  
**Finish:** Black



### LICENSE LAMP BRACKET FOR SMALL RECTANGULAR LAMPS

42162 Black

**Material:** Polycarbonate  
**Finish:** Black



### BRACKET FOR SMALL RECTANGULAR LAMPS

94233 Chrome-Plated

#### KITS:

43970 Gray (+ 67050 pigtail)

43980 Chrome-Plated (+ 67050 pigtail)

**Material:** Polycarbonate/ABS  
**Finish:** Chrome/Gray



### LICENSE LAMP MOUNTING BRACKET

43960 Gray

43962 Black

**Material:** Polycarbonate  
**Finish:** Gray/Black



### HEADER-MOUNT BRACKET FOR SMALL RECTANGULAR LAMPS

#### KITS:

43380 White (42141 + 67050)

**Material:** Polycarbonate  
**Finish:** White



### LAMP GUARD FOR SMALL RECTANGULAR LAMPS

43120 Aluminum

**Material:** Aluminum  
**Finish:** Aluminum

## 3" – 5" CLEARANCE MARKER MOUNTING

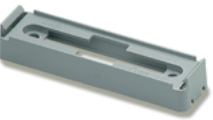

### MOUNTING BRACKET FOR LARGE RECTANGULAR LAMPS

43780 Gray Bracket

43783 Chrome-Plated Bracket, ABS

#### KITS:

43390 Gray (43780 + 66981)

43790 Gray (43780 + 66980)

**Material:** Polycarbonate/ABS  
**Finish:** Gray/Chrome



### LOW PROFILE MOUNTING BRACKET

43850 Gray

**Material:** Polycarbonate  
**Finish:** Gray

## THIN LINE CLEARANCE MARKER MOUNTING



### THIN-LINE LED LAMP GUARD

43074 Aluminum

**Material:** Aluminum  
**Finish:** Aluminum

## REPLACEMENT LENSES

LENS MODEL NUMBER	FITS LAMP	LENS MODEL NUMBER	FITS LAMP
<b>90072</b>	45662	<b>91042</b>	46302
	45712	<b>91043</b>	46303
	47262		45262
	47252	45432	49072
<b>90073</b>	45663	<b>91573</b>	45263
	45713		45433
	47263	<b>91683</b>	46543
	47253		46782
<b>90122</b>	49072	<b>91962</b>	46792
	46072		G4602
<b>90123</b>	46703		G4602-5
<b>90152</b>	45252	<b>91963</b>	46783
	49062		46793
<b>90153</b>	45253		G4603
<b>90162</b>	45412	<b>91964</b>	46792
	49042		46792-5
<b>90163</b>	45413		46793
<b>90172</b>	45462		46793-5
	45442		46782
<b>90173</b>	45463		46783
	45443	<b>92183</b>	47183
<b>90202</b>	45932	<b>92193</b>	46823
	46712	<b>92433</b>	46883
<b>90203</b>	45933	<b>92773</b>	45993
	46713	<b>99802</b>	46332
<b>90303</b>	45023	<b>99803</b>	46333
<b>90922</b>	46282	<b>99912</b>	46322
	46892	<b>99913</b>	46323
<b>90923</b>	46283		
	46293		
	46893		



90062, 90063



90072, 90073



90122, 90123



90152, 90153



90162, 90163



90172, 90173



90202, 90203



90303

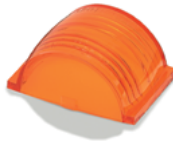

90922, 90923



91042, 91043



91572, 91573



91683



91962, 91963, 91964



92183



92193



92432, 92433



92773



99802, 99803



99912, 99913

Ford® is a registered trademark of Ford Motor Company CORPORATION DELAWARE; Kenworth® is a registered trademark of PACCAR, Inc.; Freightliner® is a registered trademark of Daimler Trucks North America, LLC; Navistar® is a registered trademark of Navistar International Corporation; Deutsch® is a registered trademark of TE Connectivity Corporation; Truck-Lite® is a registered trademark of TRUCK-LITE CO., LLC; Metri-Pack®

is a registered trademark of Aptiv Technologies Limited COMPANY BARBADOS; Valox® is a registered trademark of SABIC INNOVATIVE PLASTICS IP B.V.; Mack®; Sterling®.

All product and company names are trademarks™ or registered® trademarks of their respective holders. Use of them does not imply any affiliation with or endorsement by them.