

TRILLIANT® CUBE LED WORK LAMPS



FEATURES & BENEFITS

- Compact 4" x 4" lamps available in 1200 and 2500 lumen models
- Highest quality electronic components and advanced Grote circuit design provides electronically quiet operation. This ensures long life, consistent light output, and protection from voltage spikes and electromagnetic interference
- All-weather design means consistent, reliable light for the task duration regardless of conditions
- Rugged SAE J575E-compliant construction protects against vibration, corrosion, moisture, and dust
- Sophisticated reflector optics waste less light, focuses more light on task



63F61



63991

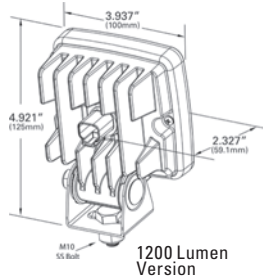

1200 Lumen Version

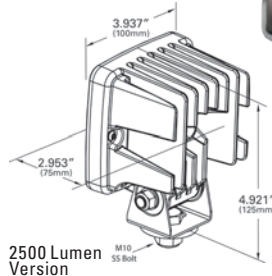

2500 Lumen Version

| Part Number | Light Pattern | Connection Type | Product Description | Light Output (Usable Lumens) | Wattage (W) | Voltage (V) | Amperage (A) |
|-------------|---------------|-----------------|--|------------------------------|-------------|-------------|--------------|
| 63981 | Flood | AMP SuperSeal | 4 x 4 work lamp w/pigtail | 1200 | 17 | 12/24 | 1.4/.7 |
| 63981-5 | Flood | AMP SuperSeal | 4 x 4 work lamp w/pigtail | 1200 | 17 | 12/24 | 1.4/.7 |
| 63991 | Wide Flood | AMP SuperSeal | 4 x 4 work lamp w/pigtail | 1200 | 17 | 12/24 | 1.4/.7 |
| 63991-5 | Wide Flood | AMP SuperSeal | 4 x 4 work lamp w/pigtail | 1200 | 17 | 12/24 | 1.4/.7 |
| 63E21 | Flood | Deustch | 4 x 4 work lamp | 1200 | 17 | 12/24 | 1.4/.7 |
| 63E31 | Wide Flood | Deustch | 4 x 4 work lamp | 1200 | 17 | 12/24 | 1.4/.7 |
| 63H31 | Flood | Deustch | 4 x 4 work lamp | 1000 | 17 | 48 | 0.35 |
| 63F21 | Flood | Deustch | High output, 4 x 4 work lamp | 2500 | 36 | 12 | 3 |
| 63F31 | Flood | Deustch | High output, 4 x 4 work lamp | 2500 | 36 | 24 | 1.5 |
| 63F41 | Wide Flood | Deustch | High output, 4 x 4 work lamp | 2500 | 36 | 12 | 3 |
| 63F51 | Wide Flood | Deustch | High output, 4 x 4 work lamp | 2500 | 36 | 24 | 1.5 |
| 63F61 | Flood | AMP SuperSeal | High output, 4 x 4 work lamp w/pigtail | 2500 | 36 | 12 | 3 |
| 63F71 | Wide Flood | AMP SuperSeal | High output, 4 x 4 work lamp w/pigtail | 2500 | 36 | 12 | 3 |

All figures listed are based on nominal voltage

Accessories

| Part Number | Description | Fits |
|-------------|---------------------------------|-------------------------|
| 68580 | AMP SuperSeal Pigtail Blunt Cut | All AMP SuperSeal lamps |
| 68610 | Deustch Pigtail Blunt Cut | All Deustch lamps |

| Materials | Certifications | Ingress Protection |
|--|---|--------------------|
| Powder Coated Cast Aluminum Housing/ Stainless Steel Bracket/ Polycarbonate Lens | ECE R10, Dir. 72/245/EEC, Amended by 2006/28/EC | IP69K |

TRILLIANT® OVAL LED WORK LAMPS



FEATURES & BENEFITS

- Available in 1200 and 2500 lumen models
- Highest quality electronic components and advanced Grote circuit design provides electronically quiet operation. This ensures long life, consistent light output, and protection from voltage spikes and electromagnetic interference
- All-weather design means consistent, reliable light for the task duration regardless of conditions
- Rugged SAE J575E-compliant construction protects against vibration, corrosion, moisture, and dust
- Two beam patterns to choose from (Flood and Wide Flood). Sophisticated reflector optics waste less light, focuses more light on task



2500 Lumen Wide Flood

63J11



1200 Lumen Flood

63F81

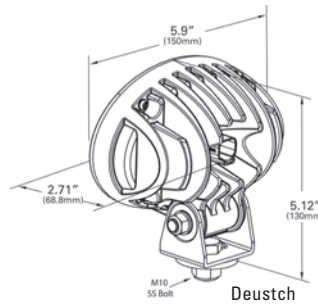

Deustch

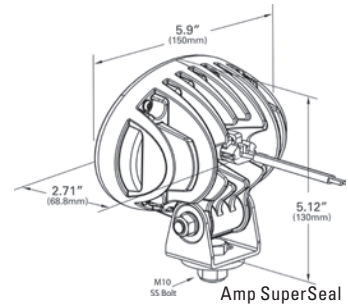

AMP SuperSeal

| Part Number | Light Pattern | Connection Type | Product Description | Light Output (Usable Lumens) | Wattage (W) | Voltage (V) | Amperage (A) |
|-------------|---|-----------------|---|------------------------------|-------------|-------------|--------------|
| 63F81 | ECE NEW | Flood | AMP SuperSeal Oval work lamp w/pigtail | 1200 | 17 | 12/24 | 1.4/.7 |
| 63F81-5 | ECE NEW RETAIL | Flood | AMP SuperSeal Oval work lamp w/pigtail | 1200 | 17 | 12/24 | 1.4/.7 |
| 63F91 | ECE NEW | Wide Flood | AMP SuperSeal Oval work lamp w/pigtail | 1200 | 17 | 12/24 | 1.4/.7 |
| 63G01 | ECE NEW | Flood | Deustch Oval work lamp | 1200 | 17 | 12/24 | 1.4/.7 |
| 63G11 | ECE NEW | Wide Flood | Deustch Oval work lamp | 1200 | 17 | 12/24 | 1.4/.7 |
| 63J01 | ECE NEW | Flood | AMP SuperSeal High output oval work lamp, w/pigtail | 2500 | 36 | 12/24 | 3/1.5 |
| 63J11 | ECE NEW | Wide Flood | AMP SuperSeal High output oval work lamp, w/pigtail | 2500 | 36 | 12/24 | 3/1.5 |
| 63J21 | ECE NEW | Flood | Deustch High output oval work lamp | 2500 | 36 | 12/24 | 3/1.5 |
| 63J31 | ECE NEW | Wide Flood | Deustch High output oval work lamp | 2500 | 36 | 12/24 | 3/1.5 |

All figures listed are based on nominal voltage

Accessories

| Part Number | Description | Fits |
|-------------|---------------------------------|-------------------------|
| 68580 | AMP SuperSeal Pigtail Blunt Cut | All AMP SuperSeal Lamps |
| 68610 | Deustch Pigtail Blunt Cut | All Deustch Lamps |

| Materials | Certifications | Ingress Protection |
|--|--|--------------------|
| Powder Coated Cast Aluminum Housing/Stainless Steel Bracket/Polycarbonate Lens | ECE R10, Dir. 72/245/EEC, Amended by 2006/28/EC CE | IP69K |

TRILLIANT® MINI LED WORK LAMPS

FEATURES & BENEFITS

- LEDs are rated for 50,000-hour for long-lasting service
- Polycarbonate hard coated lens provides many years of service
- 3X5 size makes this lamp a natural LED upgrade for many incandescent and halogen sealed beams



63602

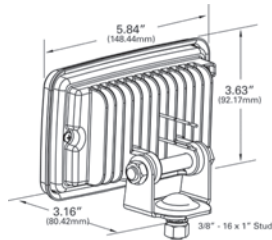

In Per-Lux® Housing 63651

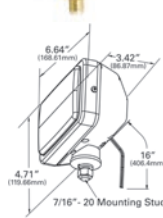

63610 Flush Mount Version

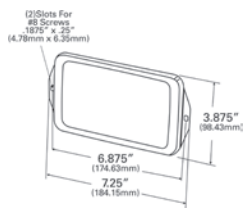

| Part Number | Light Pattern | Connection Type | Product Description | Light Output (Usable Lumens) | Wattage (W) | Voltage (V) | Amperage (A) |
|-------------|-------------------------------|-----------------|-------------------------------------|------------------------------|-------------|-------------|--------------|
| 63601 | ECE Spot | Hardwire | 3 x 5 work lamp | 750 | 10 | 12 | 0.8 |
| 63641 | ECE Spot | Hardwire | 3 x 5 work lamp in Per-Lux® housing | 750 | 10 | 12 | 0.8 |
| 63602 | ECE Spot | Hardwire | 3 x 5 work lamp featuring red LEDs | 135 | 10 | 12 | 0.8 |
| 63731 | ECE Spot | Hardwire | 3 x 5 work lamp | 750 | 10 | 24 | 0.4 |
| 63610 | ECE Flood | Hardwire | 3 x 5 flush mount work lamp | 700 | 10 | 12 | 0.8 |
| 63611 | ECE Flood | Hardwire | 3 x 5 work lamp | 700 | 10 | 12 | 0.8 |
| 63651 | ECE Flood | Hardwire | 3 x 5 work lamp in Per-Lux® housing | 700 | 10 | 12 | 0.8 |
| 63741 | ECE Flood | Hardwire | 3 x 5 work lamp | 700 | 10 | 24 | 0.4 |
| 63621 | ECE Trapezoid | Hardwire | 3 x 5 work lamp | 700 | 10 | 12 | 0.8 |
| 63661 | ECE Trapezoid | Hardwire | 3 x 5 work lamp in Per-Lux® housing | 700 | 10 | 12 | 0.8 |
| 63751 | ECE Trapezoid | Hardwire | 3 x 5 work lamp | 700 | 10 | 24 | 0.4 |

All figures listed are based on nominal voltage

Accessories

| Part Number | Description | Fits |
|-------------|--------------------------------|---|
| 94690 | Flush mount bracket and gasket | All Trilliant® Mini lamps to convert to Flush Mount |

| Materials | Certifications | Ingress Protection |
|---|--|--------------------|
| Powder Coated Die-Cast Aluminium Housing/ Polycarbonate Lens Stainless Steel Hardware | ECE R10, Dir. 72/245/EEC, Amended by 2006/28/EC | IP69K |

Work Lighting

Lampe de Travail Iluminación de Trabajo

TRILLIANT® LED WORK LAMPS

FEATURES & BENEFITS

- Long-lasting, high output LED work lamp
- Field tested in brutal off-road conditions
- Easily mountable with a durable 1/2" stud mounting bracket, also features Aim-N-Go technology
- Available in black or white housings; also some models include an integrated switch



63E41

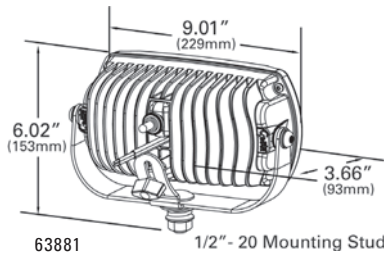

63881

1/2" - 20 Mounting Stud



White Reflector Optics Version



Lens Optics Version

| Part Number | Light Pattern | Housing Color | Product Description | Optic Design | Light Output (Usable Lumens) | Wattage (W) | Voltage (V) | Amperage (A) |
|---------------|---------------|---------------|--------------------------------------|--------------|------------------------------|-------------|-------------|--------------|
| 63571 ECE | Spot | Black | Beam pattern can be changed via lens | Lens | 1300 | 50 | 12/24 | 4.2/2.1 |
| 63671 ECE | Spot | Black | Beam pattern can be changed via lens | Lens | 1300 | 50 | 24 | 2.1 |
| 63881 ECE NEW | Spot | Black | Integrated switch | Lens | 1300 | 50 | 12/24 | 4.2/2.1 |
| 63901 ECE NEW | Spot | White | Beam pattern can be changed via lens | Lens | 1300 | 50 | 12/24 | 4.2/2.1 |
| 63581 ECE | Flood | Black | Beam pattern can be changed via lens | Lens | 1600 | 50 | 12/24 | 4.2/2.1 |
| 63681 ECE | Flood | Black | Beam pattern can be changed via lens | Lens | 1600 | 50 | 24 | 2.1 |
| 63E41 ECE NEW | Flood | Black | Lens repairable | Reflector | 2700 | 50 | 12/24 | 4.2/2.1 |
| 63E61 ECE NEW | Flood | Black | Lens repairable | Reflector | 2700 | 50 | 12/24 | 4.2/2.1 |
| 63951 ECE NEW | Flood | Black | Integrated switch | Reflector | 2700 | 50 | 12/24 | 4.2/2.1 |
| 63911 ECE NEW | Flood | White | Lens repairable | Reflector | 2700 | 50 | 12/24 | 4.2/2.1 |
| 63761 ECE | Wide Flood | Black | Lens repairable | Lens | 2300 | 50 | 12/24 | 4.2/2.1 |
| 63771 ECE | Wide Flood | Black | Lens repairable | Lens | 2300 | 50 | 24 | 2.1 |
| 63E51 ECE NEW | Wide Flood | Black | Lens repairable | Reflector | 2000 | 50 | 12/24 | 4.2/2.1 |
| 63E71 ECE NEW | Wide Flood | Black | Lens repairable | Reflector | 2000 | 50 | 24 | 2.1 |
| 63961 ECE NEW | Wide Flood | Black | Integrated switch | Reflector | 2000 | 50 | 12/24 | 4.2/2.1 |
| 63931 ECE NEW | Wide Flood | White | Lens repairable | Reflector | 2000 | 50 | 12/24 | 4.2/2.1 |
| 63591 ECE | Trapezoid | Black | Beam pattern can be changed via lens | Lens | 1400 | 50 | 12/24 | 4.2/2.1 |
| 63691 ECE | Trapezoid | Black | Beam pattern can be changed via lens | Lens | 1400 | 50 | 24 | 2.1 |

All figures listed are based on nominal voltage

Accessories

| Part Number | Description | Fits |
|-------------|------------------|----------------------------|
| 94580 | Spot Lens | 63571; 63671; 63881; 63901 |
| 94590 | Trapezoid Lens | 63591; 63691 |
| 94600 | Flood Lens | 63581; 63681 |
| 98100 | Chrome Bezel | All Trilliant® Lamps |
| 43651 | White Bracket | All Trilliant® Lamps |
| 43652 | Black Bracket | All Trilliant® Lamps |
| 21-1313-03 | Two-Hole Bracket | All Trilliant® Lamps |

| Materials | Certifications | Ingress Protection |
|--|---|--------------------|
| Powder Coated Cast Aluminum Housing/ Powder Coated Steel Bracket/Polycarbonate Lens | ECE R10, Dir. 72/245/EEC, Amended by 2006/28/EC | IP69K |

TRILLIANT® 36 LED WORK LAMPS



FEATURES & BENEFITS

- Hard coated lens for durability and protection against UV
- Thermal pull back circuit to protect the LEDs from overheating
- Aluminum housing with black powder coating
- Encapsulant potting for total circuit board protection against moisture and corrosion
- Bulb termination accommodates either screw or FastOn cable connections
- Color temperature provides a natural contrast most like sunlight, reducing eye fatigue and optimizing job performance
- Replaceable lens with three stainless steel Phillips head screws



63821



63831

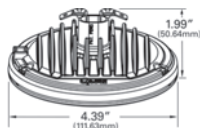

63861



63871

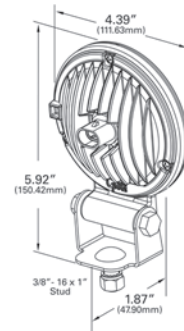

| Part Number | Light Pattern | Connection Type | Product Description | Light Output (Usable Lumens) | Wattage (W) | Voltage (V) | Amperage (A) |
|-------------|---------------|-----------------|-----------------------|------------------------------|-------------|-------------|--------------|
| 63971 | | TractorPlus | AMP SuperSeal | Replaceable bulb version | 1100 | 17 | 12/24 |
| 63H81 | | Wide Flood | AMP SuperSeal | Replaceable bulb version | 1000 | 17 | 12/24 |
| 63H01 | | Wide Flood | Deustch | Integrated bracket | 1000 | 17 | 12/24 |
| 63H11 | | TractorPlus | Deustch | Integrated bracket | 1100 | 17 | 12/24 |
| 63821-5 | | TractorPlus | Spade/Screw Terminals | Replaceable bulb version | 1100 | 17 | 12/24 |
| 63821 | | TractorPlus | Spade/Screw Terminals | Replaceable bulb version | 1100 | 17 | 12/24 |
| 63831-5 | | Wide Flood | Spade/Screw Terminals | Replaceable bulb version | 1000 | 17 | 12/24 |
| 63831 | | Wide Flood | Spade/Screw Terminals | Replaceable bulb version | 1000 | 17 | 12/24 |
| 63861-5 | | TractorPlus | AMP SuperSeal | Integrated bracket | 1100 | 17 | 12/24 |
| 63861 | | TractorPlus | AMP SuperSeal | Integrated bracket | 1100 | 17 | 12/24 |
| 63871-5 | | Wide Flood | AMP SuperSeal | Integrated bracket | 1000 | 17 | 12/24 |
| 63871 | | Wide Flood | AMP SuperSeal | Integrated bracket | 1000 | 17 | 12/24 |

All figures listed are based on nominal voltage

Accessories

| Part Number | Description | Fits |
|-------------|---------------------------------|----------------------------|
| 94300 | TractorPlus™ Lens | All TractorPlus™ T36 Lamps |
| 94310 | Flood Lens | All Flood T36 Lamps |
| 68580 | AMP SuperSeal Pigtail Blunt Cut | All AMP SS T36 Lamps |
| 68610 | Deustch Pigtail Blunt Cut | 63H01,63H11 |

| Materials | Certifications | Ingress Protection |
|---|--|--------------------|
| Powder Coated Aluminum Housing/ Polycarbonate Lens | ECE R10, Dir. 72/245/ EEC, Amended by 2006/28/EC | IP69K |

PAR 36 UTILITY LAMPS

FEATURES & BENEFITS

- For versatile application as utility, fifth-wheel, backup, tractor, forklift or off-road vehicle lamp



64101

64411

63291-5
63301-5

64111

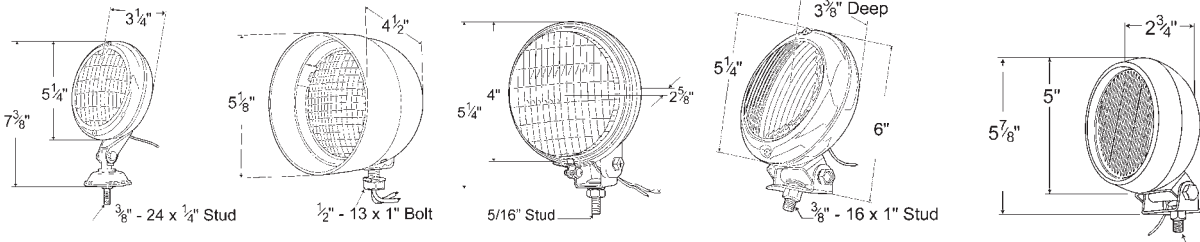
64931
64921

| Part Number | Light Pattern | Product Description | Housing Material | Light Output (CP) | Wattage (W) | Voltage (V) | Amperage (A) |
|-------------------------------|---------------|--------------------------|------------------|-------------------|-------------|-------------|--------------|
| 64931 | Tractor | Incandescent work lamp | Rubber | 3,000 | 35 | 12 | 2.7 |
| 64931-5 <small>RETAIL</small> | Tractor | Incandescent work lamp | Rubber | 3,000 | 35 | 12 | 2.7 |
| 64921 | Tractor | Incandescent work lamp | Rubber | 5,000 | 50 | 24 | 1.8 |
| 64991 | Tractor | Halogen work lamp | Rubber | 1,000 | 50 | 12 | 3.9 |
| 64101 | Tractor | Incandescent work lamp | Steel | 3,000 | 35 | 12 | 2.7 |
| 64441 | Trapezoid | Incandescent work lamp | Steel | 3,000 | 35 | 12 | 2.7 |
| 64461 | Trapezoid | Incandescent work lamp | Steel | 5,000 | 50 | 24 | 1.8 |
| 64411 | Tractor | Halogen work lamp | Plastic | 1,000 | 50 | 12 | 3.9 |
| 63291-5 <small>RETAIL</small> | Tractor | Retail display pack | Plastic | 121 | 55 | 12 | 4.7 |
| 63301-5 <small>RETAIL</small> | Tractor | Retail display pack | Plastic | 146 | 70 | 24 | 2.6 |
| 64111 | Spot | Chrome surveillance lamp | Steel | 33,000 | 35 | 12 | 2.7 |

All figures listed are based on nominal values

Accessories

| Part Number | Product Description | Fits |
|-------------|------------------------------------|----------------------|
| 64930 | Rubber Housing | Par 36 bulbs |
| 43300 | Magnet Mounting Hardware | Pedestal Mount Lamps |
| 64120 | Chrome Housing | Par 36 bulbs |
| 90861-5 | H3 Bulb | 63291-5 |
| 90971-5 | H3 Bulb | 63291-5 |
| 91051 | H3 Bulb | 63301-5 |
| 63821 | LED Replacement Bulb, TractorPlus™ | Rubber Lamps |
| 63821-5 | LED Replacement Bulb, TractorPlus™ | Rubber Lamps |
| 63831 | LED Replacement Bulb, Wide Flood | Rubber Lamps |
| 63831-5 | LED Replacement Bulb, Wide Flood | Rubber Lamps |
| 79-9005-48 | Hardware | Rubber Lamps |

Other Replacement Bulbs

| Part Number | Product Description | Fits |
|-------------|---------------------|----------------------------|
| 4411 | PAR 36 Bulb | 64931(-5), 64101 and 64441 |
| 4589 | PAR 36 Bulb | 64921 and 64461 |
| H7606 | Halogen Par 36 Bulb | 64991, 64411 and 64561 |
| 7400 | Halogen Par 36 Bulb | 64111 |

PAR 46 UTILITY LAMPS

FEATURES & BENEFITS

- For versatile application as utility, fifth wheel, back up, tractor, or off-road vehicle lamp



63921



64341
64391



64231



63941



64471
64941
64491

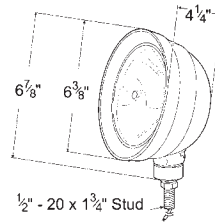
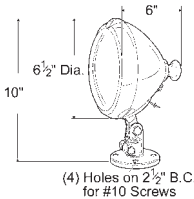
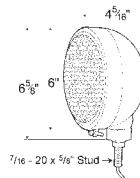
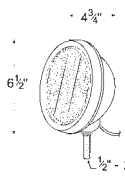

| Part Number | Light Pattern | Product Description | Housing Material | Light Output (CP) | Wattage (W) | Voltage (V) | Amperage (A) |
|-------------|---------------|---|------------------|-------------------|-------------|-------------|--------------|
| 64941 | Flood | Incandescent work lamp | Rubber | 1,100 | 35 | 12 | 2.7 |
| 64491 | Flood | Incandescent work lamp | Rubber | 32,000 | 150 | 24 | 5.4 |
| 64471 | Flood | Halogen work lamp | Rubber | 200,000 | 100 | 12 | 7.7 |
| 64943 | Flood | Incandescent work lamp, yellow lens | Rubber | 8,800 | 35 | 12 | 2.7 |
| 64341 | Tractor | Incandescent work lamp | Steel | 1,110 | 35 | 12 | 2.7 |
| 64391 | Tractor | Incandescent work lamp | Steel | 32,000 | 150 | 24 | 5.4 |
| 64231 | Tractor | Incandescent work lamp, chrome finish | Brass | 11,000 | 35 | 12 | 2.7 |
| 63921 | Spot | Halogen adjustable surveillance lamp w/ handle, chrome finish | Steel | 160,000 | 50 | 12 | 3.9 |
| 63941 | Spot | Halogen adjustable surveillance lamp, chrome finish | Steel | 75,000 | 30 | 12 | 2.3 |

All figures listed are based on nominal values

Accessories

| Part Number | Description | Fits |
|-------------|------------------------|--------------|
| 64940 | Rubber Housing | Par 46 Bulbs |
| 64340 | Steel (Black) Housing | Par 46 Bulbs |
| 64011 | Steel Housing | Par 46 Bulbs |
| 64021 | Steel (Chrome) Housing | Par 46 Bulbs |

Other Replacement Bulbs

| Part Number | Description | Fits |
|-------------|----------------------------|--|
| 4435 | Spot Pattern Par 46 Lamps | 64471, 63921, 63941 |
| 4413 | Flood Pattern Par 46 Lamps | 64941, 64491 |
| H7635 | Halogen Par 46 Lamps | 64471, 64941, 64341, 64231, 63921, 63941 |
| 4412 | Par 46 Lamps | 64471, 64941, 64341, 64231, 63921, 63941 |
| 4412A | Amber Lens Par 46 Lamps | 64943 |
| 4537 | Par 46 Lamps | 64471, 64941, 64341, 64231, 63921, 63941 |
| 4570 | 24V Par 46 Lamps | 64491, 64391 |

Work Lighting

Lampe de Travail Iluminación de Trabajo



COMPOSITE WORK LAMP

Composite design (bulb replaceable) • Multiple beam patterns for use in any application • Side or top mount • John Deere® replacement lamp

- | | | |
|----------------|----------------------|--------|
| 63111-5 | Top Mount, Flood | RETAIL |
| 63121-5 | Top Mount, Spot | RETAIL |
| 63131-5 | Top Mount, Trapezoid | RETAIL |
| 63321-5 | Side Mount, Flood | RETAIL |
| 64611 | Top Mount, Flood | |
| 64621 | Side Mount, Flood | |

Material: Nylon/Glass
Finish: Black
Bulb: 888, 95 CP; Volts / Amps: 12V / 3.9A



4" X 6" RECTANGULAR RUBBER WORK LAMP

Lamps maintains structural integrity through all weather conditions (-50°F to +150°F) • Reinforced, ribbed housing for added strength • Adjustable bracket with 12 mm diameter stud

- | | | |
|----------------|---------------|--------|
| 64891 | Flood | |
| 63211-5 | Flood | RETAIL |
| 63221-5 | Halogen, Spot | RETAIL |
| 63231-5 | Trapezoid | RETAIL |
| 64890 | Housing only | |

Material: Rubber
Finish: Black
Bulb: Flood: 4913-1, 50 Watt, 1,350 CP; Volts / Amps: 12V / 3.9A
Bulb: Spot: H7935-1, 50 Watt, 175,000 CP; Volts / Amps: 12V / 3.9A
Bulb: Trapezoid: H4651, 50 Watt, 55,000 CP; Volts / Amps: 12V / 3.9A

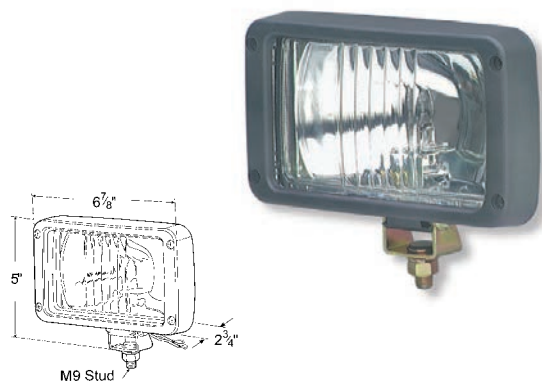

RECTANGULAR HALOGEN WORK LAMP

Available in trapezoid, spot and flood beam patterns • Rugged corrosion- and shock- resistant construction • For versatile application needs such as tractor, utility, fifth wheel, or off-road

- | | | |
|----------------|-----------|-----------|
| 63151-5 | Flood | RETAIL |
| 63161-5 | Spot | RETAIL |
| 63171-5 | Trapezoid | RETAIL |
| 63241-5 | Flood | 24 RETAIL |

Material: Nylon
Finish: Black
Bulb: 12-Volt - H3, 55 Watt, 121 CP; Volts / Amps: 12V / 4.7A
Bulb: 24-Volt - H3, 70 Watt, 146 CP; Volts / Amps: 24V / 2.7A
Accessory: Bulb: 12V 90861-5/90971-5, 24V 91051

LARGE RECTANGULAR HALOGEN WORK LAMP

Rugged corrosion and shock-resistant construction • Trapezoid, spot, and flood versions • For heavy or light duty • Versatile design suitable for applications such as tractor, utility, fifth-wheel, or off-road

- 63181-5 Flood RETAIL
- 63191-5 Spot RETAIL
- 63201-5 Trapezoid RETAIL
- 63251-5 Flood 24 RETAIL

Material: Nylon
 Finish: Black
 Bulb: 12-Volt - H3, 55 Watt, 121 CP; Volts / Amps: 12V / 4.7A
 Bulb: 24-Volt - H3, 70 Watt, 146 CP; Volts / Amps: 24V / 2.7A
 Accessory: Bulb: 12V 90861-5/90971-5, 24V 91051

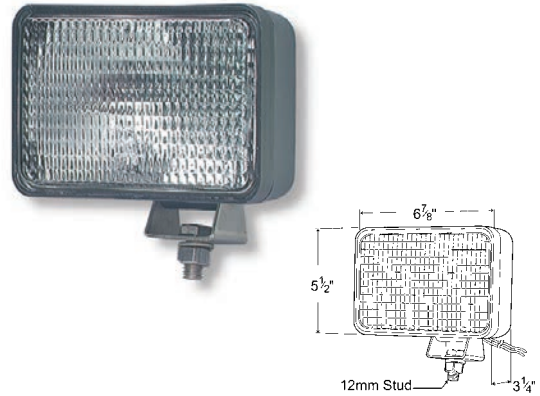

7" RECTANGULAR OFF-ROAD LAMP

Rugged steel housing • Universal swivel mounting bolt

- 64541-5 Black RETAIL

Material: Steel
 Finish: Chrome, Black
 Bulb: H3, 100 Watt, 192 CP; Volts / Amps: 12V / 8.33A
 Accessory: Bulb: 92701-5
 Lens: Clear 93151

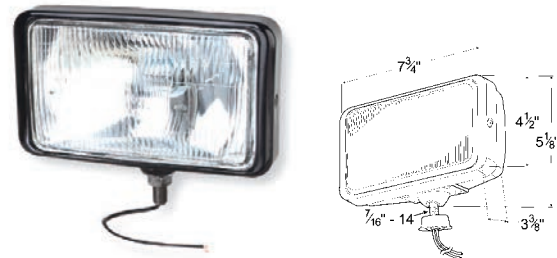

TWIN-BEAM HALOGEN WORK LAMP

Reinforced nylon housing for strength and durability • Hardened-glass lens resists breakage from road hazards • Complies with SAE J575e vibration and corrosion standards

- 64901 Flood

Material: Nylon, Glass
 Finish: Black
 Bulb: H3 (x 2); Volts / Amps: 12V / 9.4A, 55 Watt
 Accessory: Bulb: 90861-5, 90971-5

